



PRODUCT SELECTION DATA

VARIABLE-SPEED SCREW LIQUID CHILLER WITH GREENSPEED® INTELLIGENCE



- Outstanding performance
- Low sound levels
- Intelligence and connectivity
- Environmentally responsible
- Wide range of applications
- Simple installation and maintenance

30KAV-ZE 350 - 1300
30KAVPZE 350 - 800
30KAVIZE 500-1250

Nominal cooling capacity 30KAV-ZE : 372 - 1354 kW

Nominal cooling capacity 30KAVPZE : 372 - 819 kW

Nominal cooling capacity 30KAVIZE : 532 - 1307 kW

The AquaForce® Vision with Greenspeed® intelligence and PUREtec™ refrigerant is the premium solution with ultra-low GWP R-1234ze refrigerant for commercial and industrial applications where installers, consultants and building owners require superior reliability and optimal performances, especially at part load.

All units are designed to exceed European Ecodesign directive requirements in terms of energy efficiency, versatility and operating sound levels. This result is achieved through the optimised combination of proven best-in-class technologies that include:

- Refrigerant R-1234ze.
- 2nd generation of high-efficiency variable-speed twin screw compressors with built in volume index control (Vi) valve for optimal full and part load performance and Integrated Resonator Array (IRA) for low sound operation.
- 30KAVIZE is a range dedicated to Industry and eligible to comfort applications.
- 30KAVPZE premium efficiency with a Permanent Magnet technology motor. Motor is synchronous and spins without any slip and rotor losses.
- 6th generation of Carrier Flying Bird™ fans with AC or EC motor depending on options.
- Carrier flooded shell-and-tube evaporator with new copper tubes for low pressure drops
- 3rd generation of “W” profile Carrier Novation™ microchannel heat exchangers with optional Enviro-Shield coatings.
- Carrier SmartVu™ control with color touch screen user interface that includes 10 languages and new smart energy monitoring function.



CARRIER participates in the ECP programme for LCP/HP
Check ongoing validity of certificate:
www.eurovent-certification.com

AQUAFORCE® VISION WITH PURETEC™ REFRIGERANT

SUSTAINABILITY

PUREtec™: the environmental excellence solution

■ GWP<1

Carrier has selected HFO R-1234ze as the best refrigerant to replace HFC R-134a on screw chillers and heat-pumps.

HFO R-1234ze offers a **Global Warming Potential (GWP) index below 1**, similar to that of natural substances (CO₂ GWP=1).

■ High efficiency

This excellent efficiency performance in turn means a **lower total carbon footprint**, with a reduction of 10% compared to HFC R-134a and HFC blends such as R-513A.

■ Regulation compliance

Carrier has made the strategic decision to choose a long-term solution for its new chiller and heat-pump ranges using screw compressors: **HFO R-1234ze, with a GWP<1, is not impacted by the F-gas Regulation.**

AQUAFORCE® VISION THE RIGHT SOLUTION FOR EVERY APPLICATION

Carrier's AquaForce® Vision range is available in three levels of efficiency to perfectly match each customer application and meet the European Ecodesign directive requirements.

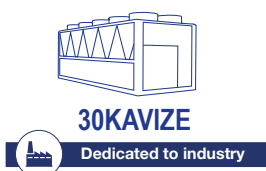
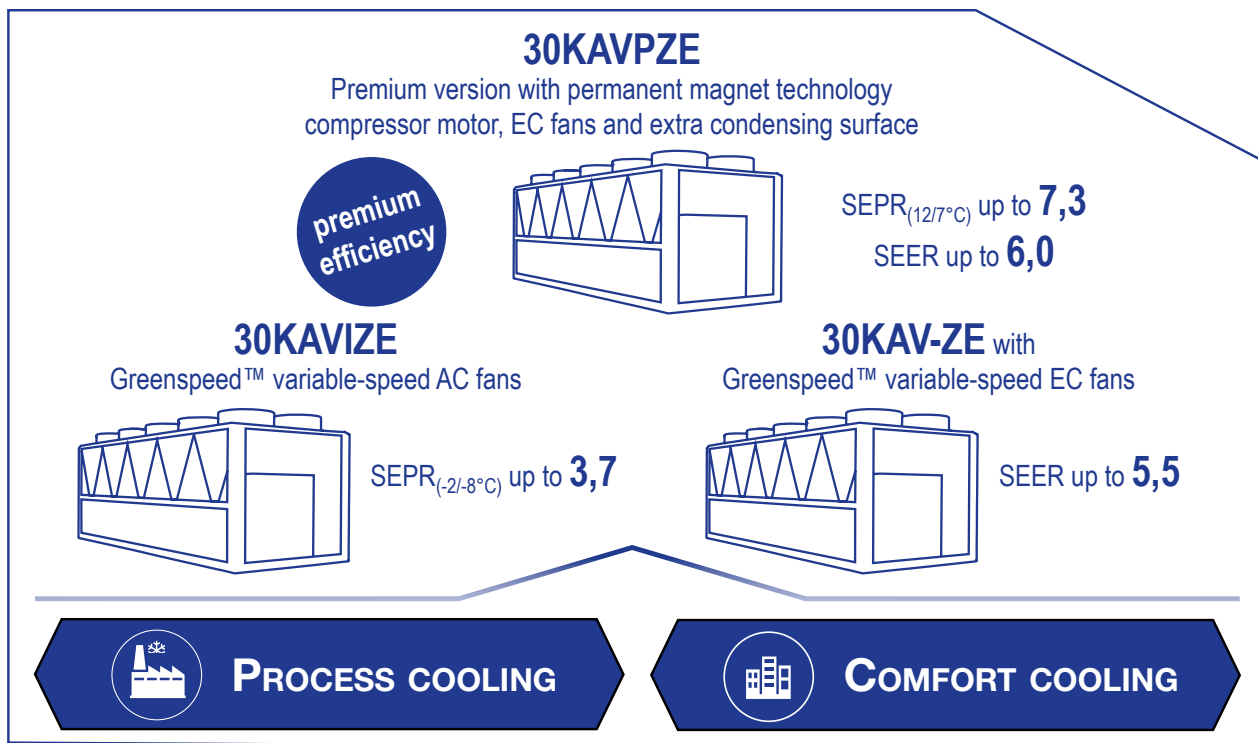

The AquaForce® 30KAVIZE dedicated to Industry is equipped with variable-speed screw compressor. The 30KAVIZE offers an economical solution whilst providing high SEPR level for process negative applications. 30KAVIZE is compliant with the 2021 EU Ecodesign SEPR -2/-8°C and 12/7°C requirements for medium and high temperature process chillers.

30KAVIZE can also eligible to comfort applications thanks to its compliance to Ecodesign SEER requirements.



The AquaForce® 30KAV-ZE with Greenspeed™ intelligence is equipped with variable-speed EC fans motors. It offers an economical solution to enhance seasonal energy efficiency levels for comfort applications. The 30KAV-ZE with Greenspeed™ intelligence meets the 2021 EU Ecodesign SEER 12/7°C requirements.



The AquaForce® 30KAVPZE with Greenspeed™ intelligence is the premium version with permanent magnet technology compressor motor, EC fans and additional heat exchange surface to improve both the full load and part load energy efficiency. The 30KAVPZE provides very cost effective operation in both process and comfort applications through the use of state of the art EC fan technology.

AQUAFORCE® VISION CUSTOMER BENEFITS

■ Outstanding performance

Equipped with variable-speed screw compressors with permanent magnet motor, EC fans and extra condensing surface, Carrier's AquaForce® Vision 30KAVPZE chiller with Greenspeed™ intelligence automatically adjusts the cooling capacity and the water flow to perfectly match the needs of the building or the process load variations.

The SEER is 25% above 2021 Ecodesign requirements.



SEER
up to 5,6

■ Low sound levels

The new generation of Carrier 06Z variable-speed twin screw compressor with integrated resonator array and the 6th generation of Flying Bird™ fans with new fan blade design inspired by nature help reduce compressor and airflow noise down to as little as 90 dB(A). This range is 6 dB(A) quieter than the previous AquaForce® 30XAV generation.



90 dB(A)

■ Intelligence and connectivity

The advanced SmartVu™ intelligent control system displays operating parameters in real time, making it intuitive and particularly user-friendly. 30KAV ranges also features innovative smart energy monitoring, providing users with smart data such as real time electric energy consumption, cooling energy output and instantaneous and average seasonal energy efficiency ratios. For further energy savings, 30KAV ranges can be monitored remotely by Carrier experts for energy consumption diagnosis and optimization.



SMART ENERGY
MONITORING

■ Environmentally responsible

Carrier's AquaForce® Vision is a boost for green cities and contributes to a sustainable future. Combining a reduced load refrigerant and exceptional energy efficiency it significantly lowers energy consumption while reducing carbon dioxide emissions by 25% throughout its life cycle.



UP TO
25% LESS
CO₂ EMISSION

■ Extensive scope of application

Carrier's AquaForce® Vision adapts effortlessly to a wide range of applications. Extended operating temperatures from -20°C to 55°C outdoor air temperatures and negative water temperatures make it ideal for various sectors of activity. From high-end office buildings and hotels to healthcare facilities, data centers and industrial projects, AquaForce® Vision meets the most demanding expectations in terms of energy efficiency and savings, whatever the climate and wherever the location.



FROM
-20°C
to **55°C**

■ Easy installation & maintenance

Built-in variable-speed pumps up to 600kW, automatic nominal water flow adjustment through electronic control, automatic unit energy performance measurement under real conditions, in units that are 25% smaller than the previous 30XAV generation, all these new features provide peace of mind for installers and service companies alike.

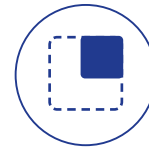

25%
SMALLER

AQUAFORCE® VISION CUSTOMER BENEFITS

AquaForce® Vision liquid chillers with Greenspeed® Intelligence adapt effortlessly to a wide range of applications. An extended operating range covering ambient temperatures from -20 to 55°C makes it ideal for all areas of activity. From high-end office buildings and hotels to healthcare facilities, data centers and industrial projects, 30KAV ranges meets the most demanding expectations in terms of energy efficiency and savings, whatever the climate and wherever the location.

Furthermore, the advanced SmartVu™ intelligent control system displays operating parameters in real time, making it intuitive and particularly user-friendly. 30KAV ranges also features innovative smart energy monitoring, providing users with smart data such as real time electric energy consumption, cooling capacity, and instantaneous and average seasonal energy efficiency ratios as well as smart refrigerant leak alert that can indicate significant loss of refrigerant at any point of the system.

For further energy savings, AquaForce® Vision can be monitored remotely by Carrier experts for energy consumption diagnosis and optimization.

AquaForce® Vision is available in 5 versions.

- 30KAVIZE is a cost effective dedicated range designed to meet industrial expectations while being eligible to comfort applications
(Average SEPR (-2/-8) of 3,6, average SEER of 5,0, average EER of 2.8)
- 30KAV-ZE standard unit
30KAV-ZE is equipped with variable-speed screw compressor and variable-speed fans with AC motors. The 30KAV-ZE is optimised to meet the most demanding technical and economic requirements while offering high seasonal energy efficiency levels.
(Average SEER of 5.2, average EER of 3.1)
- 30KAV-ZE with EC fans (option 17)
The 30KAV-ZE with EC fans option enhances the seasonal energy efficiency and offers state of the art EC fan technology as standard.
(Average SEER of 5.3, average EER of 3.1)
- 30KAV-ZE with High Energy Efficiency (option 119)
The 30KAV-ZE with High Energy Efficiency option is equipped with variable-speed fans with AC motor and additional heat exchange surface to deliver optimum performance at both full load and part load.
(Average SEER of 5.4, average EER of 3.4)
- 30KAV-ZE with High Energy Efficiency+ (option 119+)
The 30KAV-ZE with High Energy Efficiency+ option is equipped with EC fans and additional heat exchange surface to provide the highest possible seasonal energy efficiency.
(Average SEER of 5.5, average EER of 3.4)
- 30KAVPZE Premium Energy Efficiency.
The 30KAVPZE is based on 30KAV-ZE with option 119+. In addition, variable speed screw compressor is equipped with a premium permanent magnet motor. This is a synchronous motor without any slip and rotor losses.
(Average SEER of 5.6, average EER of 3.5)

Outstanding energy performance

- The 30KAV-ZE with "High energy efficiency+" is designed for very high performance both at full and part load: average SEER 5.5, average EER 3.4 as per EN14825 & EN14511.
- The 30KAVPZE with "Premium energy efficiency" is designed for very high performance both at full and part load: average SEER 5.6, average EER 3.5 as per EN14825 & EN14511.

- The high energy efficiency is achieved through:
 - 2nd generation of Carrier high-efficiency variable-speed twin-screw compressors with built in volume index control (Vi) valve for both optimal full and part load performance
 - Variable-speed Flying Bird™ fans with EC motor minimising power consumption while delivering optimum air flow
 - Novation™ aluminum condenser with high-efficiency micro-channel coils technology
 - New Carrier flooded shell-and-tube evaporator with new copper tubes for low pressure drops
 - Electronic expansion device permitting operation at a lower condensing pressure and improved utilisation of the evaporator heat exchange surface (superheat control)
 - Economiser system with electronic expansion device for increased cooling capacity.
- Optimised electrical performance:
 - Negligible start-up current (value is lower than the maximum unit current draw)
 - High displacement power factor (above 0.98)
 - EMC compliance with Class 3 requirements of the EU standard EN61800-3 (Class 2 is possible as an option).
- Hydraulic module with variable-speed dual pump
 - Variable-speed, dual pumps which automatically adjust the water flow to match the needs of the building or process load variations.
 - 3 pump control modes available: constant water flow with possibility to reduce the pump speed when there is no cooling demand, variable water flow with constant delta T or constant delta P control.
- Smart energy monitoring
 - Innovative smart energy monitoring providing users with smart data such as real time electric energy consumption, cooling capacity, and instantaneous and average seasonal energy efficiency ratios (Electricity metering accuracy: +/-5%. Cooling capacity metering accuracy: +/-5% at nominal rated conditions).
 - For further energy savings, 30KAV ranges can be monitored remotely by Carrier experts for energy consumption diagnosis and optimization.

Built-in reliability and easy servicing

The AquaForce® Vision offer enhanced performances as well as Carrier's acclaimed product quality and reliability. Major components were chosen, selected and tested to minimise the possibility of failure.

- 2nd generation of variable-speed twin-screw compressors:
 - The screw compressors are industrial-type with oversized bearings and motor cooled by suction gas, with a proven failure rate lower than 0.1%.
 - 30KAVPZE is fitted with a Permanent Magnet (PM) motor to run the variable screw compressor.
 - Motor is synchronous and spins at supplied frequency, without any slip and rotor losses to induce magnetic field. There is a benefit of +1% in full load efficiency and of +4% in part load efficiency compared to induction motors.
 - Air-cooled compressor variable-speed drive (VSD) to ensure reliable operation and easy maintenance. (Glycol-cooled variable-speed drive (VSD) types are subject to higher failure rates due to glycol pump issue. Refrigerant-cooled variable-speed drive (VSD) types are subject to higher compressor vibration levels causing possible failures in the long term).
 - Compressor bearing life exceeding 100 000 hours
 - All components related to the compressor assembly are easily accessible on site minimising down-time.

AQUAFORCE® VISION CUSTOMER BENEFITS

■ Variable-speed fans:

30KAV-ZE and 30KAVIZE are fitted with variable-speed asynchronous fan- motors as standard. One variable-speed drive (VSD) is sized to manage a group of fans per refrigerant circuit reducing first cost while ensuring high part-load efficiency.

30KAV-ZE and 30KAVIZE + option 17 and 30KAVPZE are equipped with variable speed EC fan motors. Each EC fan is controlled independently ensuring continuous chiller operation in case of motor or drive failure.

■ Air-cooled condenser:

- Novation™ aluminum micro-channel heat exchanger (MCHE) with high corrosion resistance. The all aluminum design eliminates the formation of galvanic currents between aluminum and copper that cause coil corrosion in saline or corrosive environments.
- Enviro-shield™ coating for MCHE used in standard and mildly corrosive environments with superior durability confirmed through 5000 hours testing in constant neutral salt spray per ASTM B117 and superior heat transfer performances confirmed through 2000 hours testing per CM1 (Carrier proprietary testing).
- Super Enviro-shield™ coating for MCHE used in highly corrosive environments (industry or marine applications) with superior durability confirmed through 5000 hours testing in constant neutral salt spray per ASTM B117 and superior heat transfer performances confirmed through 2000 hours testing per CM1 (Carrier proprietary testing).

■ Evaporator:

- Carrier designed flooded evaporator with mechanically cleanable water tubes
- Electronic paddle-free flow switch to ensure prompt alarm in case of poor liquid flow rate
- Thermal insulation with aluminum sheet finish (option) improved resistance to mechanical and UV damage.

■ Refrigerant circuits:

- Two independent refrigerant circuits to secure partial cooling, if one of the two develops a fault.

■ Auto-adaptive control:

- Control algorithm prevents excessive compressor cycling (Carrier patent)
- Automatic compressor unloading in case of abnormally high condensing pressure. If condenser coil fouling or fan failure occurs, the Aquaforce continues to operate, but at reduced capacity.

■ Exceptional endurance tests:

- To design critical components and sub-assemblies to minimise the risk of failure on site, Carrier uses specialised laboratories and advanced dynamic simulation tools.
- To ensure that the units reach customer sites in the same condition as they are when tested in the factory, Carrier tests the machine behavior while being moved along a 250 km trial. The test-route is based on a military standard and is the equivalent to 5000km by truck in a normal road.
- To ensure coils corrosion resistance, salt mist corrosion resistance test are performed in Carrier's laboratory.

In addition, to maintain unit performance throughout its operating life, whilst minimising maintenance costs, end users can access the "Carrier Connect" remote monitoring service.

Minimised operating sound levels

- The Greenspeed® Intelligence, featuring variable-speed screw compressors and condenser fans, minimises noise levels at part load operation.

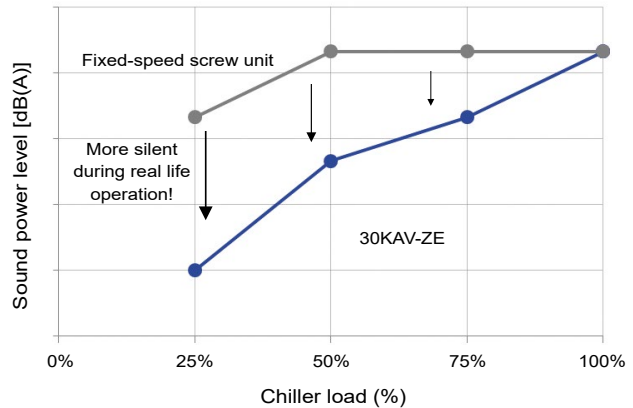

■ Standard unit features include:

- The new generation of Carrier 06Z variable-speed twin screw compressor with integrated resonator array to reduce the noise level by 6 dB(A) compared with 06T twin screw compressor previous generation.
- The 6th generation of silent Flying Bird™ fans with new fan blade design inspired by nature, help reduce airflow noise.

■ AquaForce® Vision is available with 3 sound levels to match the most sensitive environments:

- Standard: standard unit configuration with new generation of low sound screw compressor and fans
- Low noise option: addition of high-performance compressor sound enclosure
- Very low noise option: addition of high-performance compressor sound enclosure and fan operation at lower rotational speed.

Easy and fast installation

■ Built-in variable speed pumps up to 600kW

- Full hydraulic module with dual pumps (low or high pressure as required) and optional expansion tank
- Automatic nominal water flow adjustment through electronic control on the user display

■ Compact units for easy transportation and installation.

- Dimensions 25% smaller than the previous 30XAV generation
- Similar dimensions as the old 30GX chillers for easy replacement of the installed base.

■ Simplified electrical connections:

- Main disconnect switch
- Transformer supply to the integrated control circuit (400/24V)
- Single electrical point of connection

■ Simplified water connections:

- Victaulic connections on the evaporator
- Clearly identified entering and practical reference marks for entering and leaving water connections
- Possibility to choose different evaporator configurations, 1 or 2 passes.

■ Fast commissioning:

- Systematic factory operating test before shipment
- Functional test for main components, expansion devices, fans and compressors.

AQUAFORCE® VISION CUSTOMER BENEFITS

Environmental care

- The AquaForce® Vision with PUREtec™ refrigerant liquid chillers with Greenspeed® Intelligence is a boost for green cities and contributes to a sustainable future. Combining a reduced charge of R-1234ze refrigerant and exceptional energy efficiency it significantly lowers energy consumption while reducing carbon dioxide emissions by 25% throughout its life cycle (compared to previous fixed-speed screw liquid chiller generation).
- The AquaForce® Vision with PUREtec™ refrigerant liquid chiller is equipped with an automatic energy meter that provides estimated instantaneous and cumulative cooling energy output, instantaneous and cumulative electric energy consumption, instantaneous and average seasonal energy efficiency ratios (Accuracy: +/- 5% at nominal condition, +/-10% elsewhere) for unit performance monitoring and verification.
- The AquaForce® Vision with PUREtec™ refrigerant designed exclusively for HFO R-1234ze will be available during the course of 2019.
- R-1234ze: HFO refrigerant with zero ozone depletion potential
- 40% less refrigerant charge: The micro-channel technology used for condenser coils optimises heat transfer while minimising the refrigerant volume.
- Leak tight refrigerant circuits:
 - Reduction of leaks as no capillary tubes and flare connections are used
 - Verification of pressure transducers and temperature sensors without transferring refrigerant charge
 - Discharge line shut-off valve and liquid line service valve for simplified maintenance.
- Refrigerant leak alert: The AquaForce® Vision liquid chiller is equipped with an automatic refrigerant leak detection algorithm that can detect serious refrigerant loss at any point on the system (Sensitivity: 25% refrigerant charge loss per circuit, depending on the conditions). The automatic refrigerant leak detection system can help to achieve recognition within pollution prevention assessment programs, ideal for assisting in the design of sustainable buildings.
- Refrigerant leak detection: Available as an option, this additional dry-contact allows reporting of possible leaks. The leak detector (by others) should be mounted in the most likely leak location.



- R-1234ze long-term refrigerant solution
 - HFO refrigerant with nearly zero global warming potential (GWP<1 following AR5) and zero ozone depletion potential (ODP = 0).
 - Not impacted by the HFC phase-down plan in Europe (79% HFC reduction in EU member states at 2030 horizon)
 - Compliant with refrigerant regulation in Switzerland that bans the use of HFC refrigerant in large capacity airconditioning equipment.

- Leak-tight refrigerant circuit
 - Reduction of leaks as no capillary tubes and flare connections are used
 - Verification of pressure transducers and temperature sensors without transferring refrigerant charge
 - Discharge line shut-off valve and liquid line service valve for simplified maintenance.

Designed to support Green Building Design

A green building is a building that is environmentally sustainable and has been designed, constructed and is operated to minimise the total impact on the environment.

The resulting building will be economical to operate, offer increased comfort and create a healthier environment for the people who live and work there, increasing productivity.

The air conditioning system can use between 30 and 40% of the annual building energy consumption. Selection of the right air conditioning system is one of the main aspects to consider when designing a green building. For buildings with a variable load throughout the year AquaForce® Vision offer a solution to this important challenge.

A number of green building certification programs exist in the market and offer third-party assessment of green building measures for a wide variety of building types.

The following example looks at how Carrier's new AquaForce® Vision range helps customers involved in LEED® building certification.

The other benefit of using the AQUAFORCE PUREtec™ products is the eligibility for BUILDING labeling programs like BREEAM, HQE in France or Green Building Council labelling, that are recognizing the use of sustainable heating and air-conditioning equipment.

Let's take the example of BREEAM assessment method for the sustainability of buildings.

Two credits can be awarded where the refrigerants used in air-conditioning systems have a Global Warming Potential below 10.

And one additional credit can be awarded where the systems have a low Total Equivalent Warming Impact.

AQUAFORCE PUREtec™ is not only a solution that is reducing the energy bill and the CO₂ footprint.

It also helps the green certification of your buildings!

Energy saving certificate

AquaForce® Vision with with PUREtec™ refrigerant is eligible to Energy savings certificates in France (CEE) in comfort, industrial and agriculture applications:

- Floating High pressure control (by modulating the air flow through fan activation and its speed)
- Floating Low pressure control
- Variable speed on asynchronous compressor motor
- Variable speed on asynchronous fan motor
- Variable speed on asynchronous pump motor

30KAVPZE is equipped with variable speed synchronous compressor motor

For more details about financial incentives in France, please refer to "Fiche produit CEE"

AQUAFORCE® VISION CUSTOMER BENEFITS

30KAV-ZE and LEED® certification

The LEED® (Leadership in Energy and Environmental Design) green building certification programme is a preeminent programme to rate the design, construction and operation of green buildings with points assigned in seven credit categories:

- Sustainable Sites (SS)
- Water Efficiency (WE)
- Energy & Atmosphere (EA)
- Materials & Resources (MR)
- Indoor Environmental Quality (IEQ)
- Innovation in Design (ID)
- Regional Priority (RP).

There are a number of different LEED® products.

While the strategies and categories assessed remain same, the point distribution varies to address different building types and application needs, for example according to New Construction, Schools, Core & Shell, Retail and Healthcare.

All programmes now use the same point scale:

110 Possible LEED® points

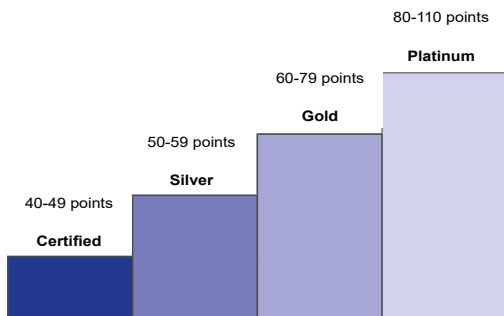

The majority of credits in LEED® rating systems are performance-based and achieving them is dependent on the impacts of each component or sub-system to the overall building.

While the LEED® green building certification programs do not certify products or services, the selection of the right products, systems or service programs is critical to obtain LEED® certification for a registered project, because the right products or service programmes can help meet the goals of green construction and ongoing operation and maintenance.

The choice of heating, ventilating and air conditioning (HVAC) products in particular can have a significant impact on LEED® certification, as the HVAC system directly impacts two categories that together influence 40% of the available points

Overview of LEED® for new construction and major renovations

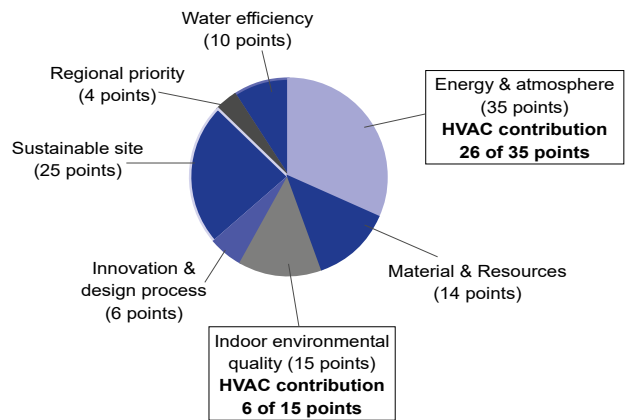

The new AquaForce® Vision with with PUREtec™ refrigerant units from Carrier can assist building owners to earn LEED® points in particular in the Energy & Atmosphere (EA) credit category and help address the following prerequisites and credit requirements:

- **EA prerequisite 2: Minimum energy Performance**
The AquaForce® Vision with with PUREtec™ refrigerant exceeds the energy efficiency requirements of ASHRAE 90,1-2007; therefore it complies with the prerequisite standard.
- **EA prerequisite 3: Fundamental Refrigerant Management**
The AquaForce® Vision with with PUREtec™ refrigerant does not use chlorofluorocarbon (CFC) refrigerants thus satisfying the prerequisite statement.
- **EA credit 1: Optimise energy performance (1 to 19 points):**
Points for this credit are assigned depending on the energy cost reduction virtually achievable by the new building, compared to ASHRAE 90,1-2007 reference. The AquaForce® Vision with with PUREtec™ refrigerant, which is designed for high performance especially during part load operation, contributes to reducing the energy consumption of the building and therefore helps in gaining points within this credit. In addition, the Carrier HAP (Hourly Analyses Program) can be used as an energy analyses program complying with the modeling requirements for this credit and produce reports that are easily transferable to LEED® templates.
- **EA credit 4: Enhanced refrigerant management (2 points):**
With this credit, LEED® awards systems that minimise the Ozone Depletion Potential (ODP) and Global Warming Potential (GWP) of the system. The AquaForce® Vision with with PUREtec™ refrigerant uses a reduced R-1234ze charge and therefore contributes toward satisfying this credit under LEED®.

30KAV-ZE TECHNICAL INSIGHTS

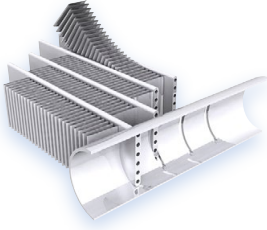

3RD GENERATION OF “W” SHAPE NOVATION® MICRO CHANNEL HEAT EXCHANGERS

- Exclusive Carrier design
- Increased reliability with new aluminum alloy
- Significantly reduces refrigerant charge (-40% vs cu/al coils)
- More compact units (-25% vs previous 30XAV generation)
- Enviro-shield™ coating for mildly corrosive environments
- Super Enviro-shield™ coating for highly corrosive environments (industry or marine applications)
- Easy cleaning with high pressure air or water washer

ADVANCED SMARTVU™ WITH 7 INCH COLOR TOUCH SCREEN INTERFACE

- Exclusive Carrier design
- 10 languages available: DE, EN, ES, FR, IT, NL, PT, TR, TU + one additional customer choice
- Touch screen user interface
- BACnet, J-Bus or LON communication interfaces
- Optional wireless connectivity



POWERFUL SMART ENERGY MONITORING FUNCTION

- Provides smart data based on intelligent algorithms
- Real time energy consumption measurement (kWh)
- Cooling energy output measurement (kWh)
- Instantaneous and average Energy Efficiency Ratio under real operating conditions
- Remote monitoring with Carrier Connect

FLOODED SHELL AND TUBE EVAPORATOR

- Exclusive Carrier design
- Flooded technology for high energy efficiency
- New generation of copper tubes with specific profile to reduce pressure drops when operating with glycol



6TH GENERATION OF VARIABLE-SPEED FLYING BIRD™ FANS WITH AC OR EC MOTOR

- Exclusive Carrier design
- Fan blade design inspired by nature
- AC motor technology
- High efficiency version with EC motor technology (option)



VARIABLE-SPEED DUAL PUMPS WITH AC MOTOR

- Dual pumps designed for variable speed operation
- High efficiency AC motor
- Low static pressure (~100 kPa) or high static pressure (~180 Kpa) available
- 3 pump control modes available: constant water flow with 2 speeds, variable water flow based on constant delta T or constant delta P
- Compatibility of chillers for variable primary flow operation

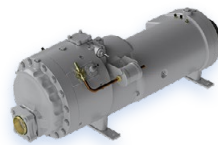

LATEST GENERATION CARRIER VARIABLE-SPEED 06Z TWIN SCREW COMPRESSOR WITH AC MOTOR

- Exclusive Carrier design
- Twin screw compressor designed for variable speed operation
- High efficiency AC motor
- Stepless variable-speed control (0%-100%)
- Integrated resonator array for compressor acoustic attenuation
- Integrated check valve for quiet shutdown
- Air-cooled inverter drive for increased reliability
- Bearing life exceeding 100.000 hours
- Twin screw compressor with permanent magnet motor as option

30KAVPZE TECHNICAL INSIGHTS

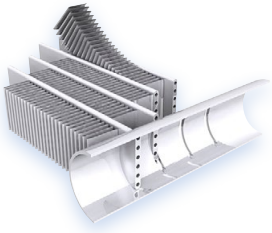

3RD GENERATION OF "W" SHAPE NOVATION[®] MICRO CHANNEL HEAT EXCHANGERS

- Exclusive Carrier design
- Increased reliability with new aluminum alloy
- Significantly reduces refrigerant charge (-40% vs cu/al coils)
- More compact units (-25% vs previous 30XAV generation)
- Enviro-shield™ coating for mildly corrosive environments
- Super Enviro-shield™ coating for highly corrosive environments (industry or marine applications)
- Easy cleaning with high pressure air or water washer
- Extra W module to increase seasonal efficiency



6TH GENERATION OF VARIABLE-SPEED FLYING BIRD™ FANS WITH EC MOTOR

- Exclusive Carrier design
- Fan blade design inspired by nature
- High efficiency version with EC motor

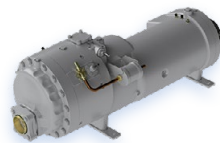

LATEST GENERATION CARRIER VARIABLE-SPEED 06Z TWIN SCREW COMPRESSOR WITH PERMANENT MAGNET MOTOR

- Exclusive Carrier design
- Twin screw compressor designed for variable speed operation
- High efficiency permanent magnet motor
- Stepless variable-speed control (0%-100%)
- Integrated resonator array for compressor acoustic attenuation
- Integrated check valve for quiet shutdown
- Air-cooled inverter drive for increased reliability
- Bearing life exceeding 100.000 hours

TECHNICAL INSIGHTS

NOTE: This section describes the prerequisites and credit requirements in LEED® for New Construction and is directly related to the AquaForce® Vision. Other prerequisites and credit requirements are not directly and purely related to the air-conditioning unit itself, but more to the control of the complete HVAC system.

i-Vu®, Carrier's open control system, has features that can be valuable for:

- EA prerequisite 1: Fundamental commissioning of energy management system
- EA credit 3: Enhanced commissioning (2 points)
- EA credit 5: Measurements and verification (3 points).

NOTE: Products are not reviewed or certified under LEED®. LEED® credit requirements cover the performance of materials in aggregate, not the performance of individual products or brands. For more information on LEED®, visit www.usgbc.org.

SmartVu™



- New innovative smart control features:
 - An intuitive and user-friendly, coloured, 7" interface
 - 10 languages available on choice: DE, EN, ES, FR, IT, NL, PT, TR, TU + one additional customer choice
 - Screen-shots with concise and clear information in local languages
 - Complete menu, customised for different users (end user, service personnel and Carrier-factory technicians)
 - Setpoint offset based on the outside air temperature
 - Safe operation and unit setting: Password protection ensures that unauthorised people cannot modify any advanced parameters
 - Simple and "smart" intelligence uses data collection from the constant monitoring of all machine parameters to optimise unit operation
 - Night-mode: Cooling capacity management for reduced noise level.
 - With hydraulic module: Water pressure display and water flow rate calculation.
- Energy management:
 - Innovative smart energy monitoring, providing users with smart data such as real time electric energy consumption, cooling capacity, and instantaneous and average seasonal energy efficiency ratios.
 - Internal time schedule clock controls chiller on/off times and operation at a second set-point
 - The DCT (Data Collection Tool) records the alarms history to simplify and facilitate service operations.
- Maintenance functions
 - F-Gas regulation leak check reminder alert
 - Maintenance alert can be configured to days, months or hours of operation

- Advanced communication features
 - Easy and high-speed communication technology over Ethernet (IP) to a centralised building management system
 - Access to multiple unit parameters.

Remote management (standard)

- Units with SmartVu™ control can be easily accessed from the internet, using a PC with an Ethernet connection. This makes remote control quick and easy and offers significant advantages for service operations.
- Aquaforce with Greenspeed® Intelligence is equipped with an RS485 serial port that offers multiple remote control, monitoring and diagnostic possibilities. When networked with other Carrier equipment through the CCN (Carrier Comfort Network - proprietary protocol), all components form a HVAC system fully-integrated and balanced through one of the Carrier's network system products, like the Chiller System Manager or the Plant System Manager (optional).
- Units also communicates with other building management systems via optional communication gateways (BACnet, LON or JBus).
- The following commands/visualisations are possible from remote connection:
 - Start/Stop of the machine
 - Dual set-point management: Through a dedicated contact is possible to activate a second set-point (example, unoccupied mode)
 - Demand limit setting: To limit the maximum chiller capacity to a predefined value
 - Water pump control: These outputs control the contactors of one/two evaporator water pumps.
 - Water pumps changeover (only with hydraulic module options): These contacts are used to detect a water pump operation fault and automatically change over to the other pump.
 - Operation visualisation: Indication if the unit is operating or if it is in stand-by (no cooling load)
 - Alarm visualisation.

Remote management (EMM option)

- The Energy Management Module (EMM) offers extended remote control possibilities:
 - Room temperature: Permits set-point reset based on the building indoor air temperature (if Carrier thermostats are installed)
 - Set-point reset: Allows reset of the cooling set-point based on a 4-20 mA.
 - Demand limit 1 and 2: Closing of these contacts limits the maximum chiller capacity to two predefined values.
 - User safety: This contact can be used for any customer safety loop; opening the contact generates a specific alarm.
 - Ice storage end: When ice storage has finished, this input permits return to the second set-point (unoccupied mode).
 - Time schedule override: Closing of this contact cancels the programmed time schedule.
 - Out of service: This signal indicates that the chiller is completely out of service.
 - Chiller capacity: This analogue output (0-10 V) gives an immediate indication of the chiller capacity.
 - Alert indication: This volt-free contact indicates the necessity to carry out a maintenance operation or the presence of a minor fault.
 - Compressors running status: Set of outputs (as many as the compressors number) indicating which compressors are running.

TECHNICAL INSIGHTS

New generation of Carrier 06Z variable-speed twin screw compressor

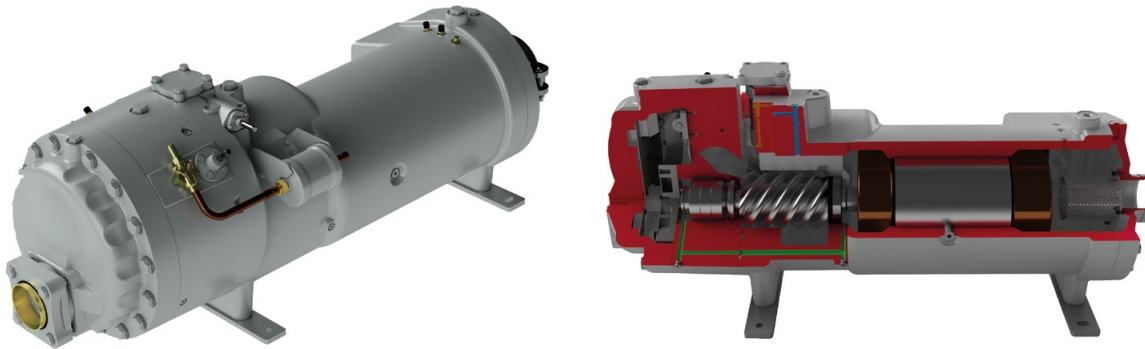

The new generation of 06Z variable-speed twin screw compressors benefits from Carrier's long experience in the development of twin-rotor screw compressors. The 06Z compressor design is based on the successful 06T screw compressor, core of the well-known Aquaforce series with a number of modifications to reduce noise level and improve the energy efficiency especially during part load operation.

- New 06Z twin screw compressor optimized for variable speed operation: elimination of the slide valve, built-in volume index control (Vi) valve for both optimal full and part load performance, high efficiency AC motor with stepless inverter control from 20% to 100%.
- 30KAVPZE screw compressor is equipped with a Permanent Magnet (PM) Motor, which is a four pole motor compared to the two pole induction motor. By the way, the frequency setting doubles with PM motors, but the shaft speed remains the same. There is no slip or rotor losses. Thus, there is a benefit of +1% in full load efficiency and of +4% in part load efficiency.

Permanent Magnet Motor



- Separate air-cooled inverter drive for increased reliability
- New 06Z twin screw compressor design with Integrated Resonator Array (IRA) to reduce the sound level by up to 6 dB(A) when compared with previous 06T generation
- Integrated Check Valve for quiet shutdown
- Bearing life exceeding 100 000 hours.
- A dedicated oil separator is installed at the discharge of each compressor to ensure maximum oil return: Oil separates from refrigerant by gravity and returns to the low pressure side of the compressor without use of additional pumps.
- Volume index control (Vi) valve provides a reliable method of adjusting the compression ratio to better match system demand. It provides optimal performance regardless of operating condition
- Screw compressors work on the positive displacement principle to compress gas to a higher pressure. As a result, if there is an unusually high pressure in the condenser (due for example to coil fouling or operation in harsh climate) the compressor does not switch off, but continues operation at reduced capacity (unloaded mode).
- The silencer in the oil separator line (at the compressor outlet) considerably reduces discharge gas pulsations for much quieter operation.

TECHNICAL INSIGHTS

Novation® Heat Exchangers with Microchannel Coil Technology

Already utilised in the automobile and aeronautical industries for many years, the Novation™ Micro-Channel Heat Exchanger (MCHE) used in the Aquaforce is entirely made of aluminum. This one-piece concept significantly increases its corrosion resistance by eliminating the galvanic currents that are created when two different metals (copper and aluminum) come into contact in traditional heat exchangers.

- From the energy efficiency point-of-view the Novation® heat exchangers are approximately 10% more efficient than traditional coils and micro-channel coil technology allows a 40% reduction in the amount of refrigerant used in the chiller.
- The reduced depth of the Novation™ MCHE reduces air pressure losses by 50% and makes it much less susceptible to fouling (e.g. by sand). Cleaning of the Novation™ MCHE heat exchanger is very fast using a high pressure washer.
- To further enhance long-term performance, and protect coils from early deterioration, Carrier offers (as options) dedicated treatments for installations in corrosive environments.
 - The Novation™ MCHE with Enviro-Shield protection (option 262) is recommended for installations in moderately corrosive environments. The Enviro-Shield protection utilises corrosion inhibitors which actively arrest oxidation in case of mechanical damage.
 - The Novation™ MCHE with exclusive Super Enviro-Shield protection (option 263) is recommended for installations in corrosive environments. The Super Enviro-Shield protection consist of an extremely durable and flexible epoxy coating uniformly applied over all coil surfaces for complete isolation from the contaminated environment.
- After a total of more than 7,000 hours of testing following various test standards in Carrier laboratories, the Carrier Novation® MCHE with Super Enviro-shield® coating appears to be the best-suited customer choice to minimize the harmful effects of corrosive atmospheres and ensure long equipment life.
 - Best corrosion resistance per ASTM B117/D610 test
 - Best heat transfer performance per Carrier Marine 1 test
 - Proven reliability per ASTM B117 test



Coil Types (ranked by performance)	Visual Corrosion Evaluation	Heat Transfer Performance Degradation	Time to Failure	Test Campaign Conclusions
Super Enviro-shield® Novation™ MCHE	Very good	Good	No coil leak	Best
Super Enviro-shield® Cu/Al coil	Very good	Very good	No coil leak	Very good
Enviro-shield® Novation™ MCHE	Very good	Good	No coil leak	Very good
Al/Al coil	Very good	Good	No coil leak	Very good
Novation™ MCHE	Good	Very good	No coil leak	Good
Cu/Cu coil	Good	Good	Leak	Acceptable
Blygold® Cu/Al coil	Good	Good	No coil leak	Acceptable
Precoat Cu/Al coil	Bad	Bad	No coil leak	Bad
Cu/Al coil	Bad	Bad	No coil leak	Bad

TECHNICAL INSIGHTS

New generation of Flying Bird VI fans with EC motors



AquaForce® Vision utilizes Carrier's the 6th generation Flying Bird™ fan technology, engineered for maximum efficiency, super low noise, and wide operating range. The fan includes Carrier patented rotating shroud technology and back-swept blades with a unique wave-serration trailing edge inspired from nature.

It was designed and optimized for the AquaForce® Vision air management system configuration and heat exchanger technology. On 30KAVPZE, 30KAV-ZE and on 30KAVIZE with option 17 , fans are propelled by an EC motor, also known as brushless DC, with a unique electronics to manage commutation. This provides a great accuracy for fans that require higher efficiencies and variable speed. The fan meets the latest European eco-design requirements for fan efficiency. The fan uses Carrier's robust and proven injection molded composite-thermoplastic construction.

EC fan



TECHNICAL INSIGHTS

Variable Frequency Drives (VFD)

The compressors, AC fans and the pumps of AquaForce® Vision are controlled by VFDs.

- Electrical box is capable of operating up to 55°C (with option 16 "High Ambient").
- Unit controls is capable of withstanding storage temperatures in the control compartment from -20°C to 68°C.
- All VFDs on the chiller (compressors, fans and pumps motors) are fully air cooled and shall not require an additional glycol cooling system, thus avoiding the maintenance associated with such cooling systems.



Fan drives + Pump drives +
electronic boards



Compressor drives + main
power connection

OPTIONS

Option	No.	Description	Advantage	Use 30KAV-ZE	Use 30KAVPZE	Use 30KAVIZE
Medium Brine down to -6°C	5	Redesigned evaporator to allow chilled brine solution production down to -6°C (including different number of tubes in the evaporator, extra insulation, specific sensors and algorithms).	Covers specific applications such as ice storage and industrial processes.	0350-1300	0350-0800	0500-1250
Low Brine with turbulators down to -12°C	6	Redesigned evaporator including turbulators to allow chilled brine solution production with low pressure drops on the entire negative application range, down to -12°C (including turbulators, extra insulation, specific sensors and algorithms).	Covers specific applications such as ice storage and industrial processes.	0350-1300	0350-0800	0500-1250
Low noise level	15	Aesthetic and sound absorbing compressor enclosure	Noise level reduction	0350-1300	0350-0800	0500-1250
Very low noise level	15LS	Sound absorbing & aesthetic compressor enclosure and oil separator, evaporator and suction line acoustic treatment, combined with low-speed fans	Noise level reduction for sensitive site	0350-1300	0350-0800	0500-1250
High ambient temperature	16	Electrical components sized for part load operation up to 55°C air ambient	Extended unit part-load operation up to 55°C ambient temperature	0350-1300	0350-0800	NO
EC fans	17	Unit equipped with EC fans	Enhances the unit energy efficiency	0350-1300	NO	0500-1250
IP54 control box	20A	Increased leak tightness of the unit	Protects the inside of the electrical box from dust, water and sand. In general this option is recommended for installations in polluted environments	0350-1300	0350-0800	0500-1250
Grilles and enclosure panels	23	Metal protection grilles and side enclosure panels	Improves aesthetics, protection against intrusion to the unit interior, coil and piping protection against impacts.	0350-1300	0350-0800	0500-1250
Enclosure panels	23A	Side enclosure panels	Improves aesthetics and piping protection against impacts.	0350-1300	0350-0800	0500-1250
Water exchanger frost protection	41A	Electric resistance heater on the water exchanger and discharge valve	Water exchanger frost protection down to -20°C outside temperature	0350-1300	0350-0800	0500-1250
Evaporator and hydraulic module frost protection	41B	Electric resistance heater on water exchanger, discharge valve and hydraulic module	Water exchanger and hydraulic module frost protection down to -20°C outside temperature	0350-0600	0350-0600	NO
Evaporator & recovery condenser frost protection	41C	Electric resistance heater on evaporator exchanger, discharge valve and add heaters and insulation on hydraulic connection (option 325)	Water exchanger module frost protection between 0°C and -20°C outside air temperature	0350-1300	0350-0800	0500-1250
Partial heat recovery	49	Unit equipped with one desuperheater on each refrigerant circuit	Production of free high-temperature hot-water simultaneously with chilled water production (or hot water for Heat pump)	0350-0800	0350-0800	NO
Total heat recovery	50	Unit equipped with an additional heat exchanger in series with the condenser coils (Each heat exchanger is equipped with electrical heaters and insulation)	Production of free hot-water with variable heat reclaim	0350-1300	0350-0800	0500-1250
Boosted Total Heat Recovery	50+	Unit equipped with additional heat exchanger in series with the condenser coils, and valves to isolate part of the coils.	Production of free hot-water simultaneously with chilled water production. Coils isolation reduce the condensing area leading to improve heat recovery efficiency.	0900-1300	NO	0500-1250
Master/slave operation	58	Unit equipped with supplementary leaving water temperature sensor kit (to be field installed) allowing master/slave operation of two units connected in parallel	Optimised operation of two units connected in parallel operation with operating time equalisation	0350-1300	0350-0800	0500-1250
Main disconnect switch with short-circuit protection	70D	Circuit breaker equipped with an external disconnect switch handle	Ensure protection of main disconnect switch and associated cables against short-circuits when building devices are not compliant	0350-1300	0350-0800	0500-1250
Evap. and pumps with aluminium jacket	88A	Evaporator and pumps covered with an aluminium sheet for thermal insulation protection	Improved resistance to aggressive climate conditions	0350-0600	0350-0600	NO
Service valve set	92	Liquid line valve (evaporator inlet) and compressor suction line valve	Allow isolation of various refrigerant circuit components for simplified service and maintenance	0350-1300	0350-0800	0500-1250
Compressor discharge valves	93A	Shut-off valve on the compressor discharge piping	Simplified maintenance	0350-1300	0350-0800	0500-1250
21 bar evaporator	104	Reinforced evaporator for extension of the maximum water-side service pressure to 21 bar (standard 10 bar)	Covers applications with a high water column on the condenser side (typically high buildings)	0350-1300	0350-0800	0500-1250

OPTIONS

Option	No.	Description	Advantage	Use 30KAV-ZE	Use 30KAVPZE	Use 30KAVIZE
LP VSD dual-pump hydraulic mod.	116A	Dual low-pressure water pump with variable speed drive (VSD), pressure transducers. Multiple possibilities of water flow control. For more details, refer to the dedicated chapter.	Easy and fast installation (plug & play), significant pumping energy cost savings (more than two-thirds), tighter water flow control, improved system reliability	0350-0600	0350-0600	NO
HP VSD dual-pump hydraulic mod.	116W	Dual high-pressure water pump with variable speed drive (VSD), pressure transducers. Multiple possibilities of water flow control (expansion tank with built-in safety hydraulic components available in option)	Easy and fast installation (plug & play), significant pumping energy cost savings (up to two-thirds), tighter water flow control, improved system reliability	0350-0600	0350-0600	NO
High Energy Efficiency	119	Additional condenser coil to improve unit energy efficiency	Enhances the unit energy efficiency performance	0350-1100	NO	NO
High Energy Efficiency+	119+	Additional condenser coil plus EC fans to improve unit energy efficiency	Enhances the unit energy efficiency performance	0350-1100	NO	NO
Lon gateway	148D	Bi-directional communication board complying with Lon Talk protocol	Connects the unit by communication bus to a building management system	0350-1300	0350-0800	0500-1250
Bacnet over IP	149	Bi-directional high-speed communication using BACnet protocol over Ethernet network (IP)	Easy and high-speed connection by ethernet line to a building management system. Allows access to multiple unit parameters	0350-1300	0350-0800	0500-1250
Modbus over IP and RS485	149B	Bi-directional high-speed communication using Modbus protocol over Ethernet network (IP)	Easy and high-speed connection by ethernet line to a building management system. Allows access to multiple unit parameters	0350-1300	0350-0800	0500-1250
Energy Management Module	156	EMM Control board with additional inputs/outputs. See Energy Management Module option chapter	Extended remote control capabilities (Set-point reset, ice storage end, demand limits, boiler on/off command...)	0350-1300	0350-0800	0500-1250
Input contact for Refrigerant leak detection	159	0-10 V signal to report any refrigerant leakage in the unit directly on the controller (the leak detector itself must be supplied by the customer)	Immediate customer notification of refrigerant losses to the atmosphere, allowing timely corrective actions	0350-1300	0350-0800	0500-1250
Dual relief valves on 3-way valve	194	Three-way valve upstream of dual relief valves on the shell and tubes evaporator	Valve replacement and inspection facilitated without refrigerant loss. Comforms to European standard EN378/BGVD4	0350-1300	0350-0800	0500-1250
Compliance with Swiss regulations	197	Additional tests on the water heat exchangers: supply (additional of PED documents) supplementary certificates and test certifications	Conformance with Swiss regulations	0350-1300	0350-0800	0500-1250
Compliance with Russian regulations	199	EAC certification	Conformance with Russian regulations	0350-1300	0350-0800	0500-1250
Compliance with Australian regulations	200	Unit approved to Australian code	Conformance with Australian regulations	0350-1300	0350-0800	0500-1250
Insulation of the evap. in/out ref. lines	256	Thermal insulation of the evaporator entering/leaving refrigerant lines with flexible, UV resistant insulation	Prevents condensation on the evaporator entering/leaving refrigerant lines	0350-1300	0350-0800	0500-1250
Enviro-Shield anti-corrosion protection	262	Coating by conversion process which modifies the surface of the aluminum producing a coating that is integral to the coil. Complete immersion in a bath to ensure 100% coverage. No heat transfer variation, tested 4000 hours salt spray per ASTM B117	Improved corrosion resistance, recommended for use in moderately corrosive environments	0350-1300	0350-0800	0500-1250
Super Enviro-Shield anti-corrosion protection	263	Extremely durable and flexible epoxy polymer coating applied on micro channel heat exchangers by electro coating process, final UV protective topcoat. Minimal heat transfer variation, tested 6000 hours constant neutral salt spray per ASTM B117, superior impact resistance per ASTM D2794	Improved corrosion resistance, recommended for use in extremely corrosive environments	0350-1300	0350-0800	0500-1250
Welded evaporator connection (kit)	266	Victaulic piping connections with welded joints	Easy installation	0350-1300	0350-0800	0500-1250
Welded heat recovery condenser connection (kit)	267	Victaulic piping connection with welded joints	Easy installation	0350-1300	0350-0800	0500-1250
Evaporator with aluminum jacket	281	Evaporator covered with an aluminum sheet for thermal insulation protection	Improved resistance to aggressive climate conditions	0350-1300	0350-0800	0500-1250
EMC class. C2, as per EN 61800-3	282	Additional RFI filters on the unit power line	Reduces electromagnetic interferences for compliance with emission level category C2 in order to allow the units to operate in the first environment (so called, residential environment)	0350-1300	0350-0800	0500-1250

OPTIONS

Option	No.	Description	Advantage	Use 30KAV-ZE	Use 30KAVPZE	Use 30KAVIZE
230V electrical plug	284	230V AC power supply source provided with plug socket and transformer (180 VA, 0,8 Amps)	Permits connection of a laptop or an electrical device during unit commissioning or servicing	0350-1300	0350-0800	0500-1250
Expansion tank	293	6 bar expansion tank integrated in the hydraulic module (requires hydraulic module option)	Easy and fast installation (plug & play), & Protection of closed water systems from excessive pressure	0350-0600	0350-0600	NO
Electric energy meter	294	Electricity meter . Display of energy consumption, instantaneous (U, V, I) and cumulated (kWh) on the unit user interface datas available on communication bus	Permits the acquisition, (remote) monitoring of energy used.	0350-1300	0350-0800	0500-1250
Fast Capacity Recovery	295	New software algorithms to allow quick restart and fast loading while preserving unit-reliability	Full capacity recovery in less than 5 minutes after power failure. Matches requirements of typical critical missions applications	0350-1300	0350-0800	0500-1250
Ultra Fast Capacity Recovery	295+	Electrical battery to enable quick restart and fast loading preserving unit reliability	Full capacity recovery in less than 1 minute after power failure. Matches requirements of typical critical missions applications.	0350-1300	0350-0800	0500-1250
Mexico screw compressor	297	Screw compressor made in Mexico		0350-1300	NO	0500-1250
Variable Water Flow control	299	Hydraulic control function package that permits control of the water flow rate based on different possible logics (at customer choice): constant delta T, constant outlet pressure and "fixed-speed" control	When variable-speed pumps on the primary circuit, the VWF control modulates flow rate through the evaporator, minimising pump consumption while ensuring safe/ optimised chiller operation	0350-1300	0350-0800	0500-1250
Free-cooling dry-cooler control	313	Control & connections to a Free Cooling Drycooler 09PE or 09VE fitted with option FC control box	Easy system management, Extended control capabilities to a drycooler used in Free Cooling mode	0350-1300	0350-0800	0500-1250
Compliance with UAE regulation	318	Additional label on the unit with rated power input, rated current and EER following AHRI 550/590	Compliance with ESMA standard UAE.S 5010-5:2019.	0350-1300	0350-0800	0500-1250
Compliance with Qatar regulation	319	Specific nameplate on the unit with power supply 415 V+/-6%	Compliance with KAHRAMAA regulation in Qatar.	0350-1300	0350-0800	0500-1250
Hydraulic connection kit	325	Water piping on condenser and evaporator side	Easy installation	0350-1300	0350-0800	0800-1250
Compliance with Morocco regulation	327	Specifics documents according Morocco regulation	Conformance with Morocco regulations	0350-1300	0350-0800	0500-1250
Compressor with permanent magnet	329	Screw compressor equipped with permanent magnet motor	Permanent magnet motor improves significantly compressor efficiency	0350-0800	NO	0500-0800
Neutral IT System	333	Specific earthing that isolates the neutral point from the ground.	The device still works after the first electrical isolation failure and enables the exploitation continuity (industrial processes, hospitals).	0350-1300	0350-0800	0500-1250

PHYSICAL DATA

Standard units - Units 350 - 800 kW

30KAV-ZE		350	400	450	500	550	600	650	750	800		
Cooling												
Standard unit Full load performances*	CA1	Nominal capacity	kW	372	404	458	483	533	606	673	751	823
		EER	kW/kW	3,08	3,01	3,13	3,08	3,13	3,15	3,18	3,17	3,20
Standard unit Seasonal energy efficiency **		SEER_{12/7°C} Comfort low temp.	kWh/kWh	4,99	4,99	5,20	5,19	5,30	5,20	5,19	5,16	5,30
		ηs cool_{12/7°C}	%	197	197	205	205	209	205	205	204	209
		SEPR_{12/7°C} Process high temp.	kWh/kWh	5,40	5,68	6,45	6,52	6,46	6,43	6,40	6,32	6,49
Unit + option 17 Seasonal energy efficiency **		SEER_{12/7°C} Comfort low temp.	kWh/kWh	5,05	5,05	5,27	5,28	5,38	5,27	5,28	5,24	5,39
		ηs cool_{12/7°C}	%	199	199	208	208	212	208	208	207	213
		SEPR_{12/7°C} Process high temp.	kWh/kWh	5,43	5,72	6,54	6,64	6,57	6,53	6,51	6,41	6,60
Unit + option 329 Seasonal energy efficiency **		SEER_{12/7°C} Comfort low temp.	kWh/kWh	5,15	5,15	5,37	5,36	5,47	5,36	5,36	5,32	5,47
		ηs cool_{12/7°C}	%	203	203	212	211	216	211	211	210	216
		SEPR_{12/7°C} Process high temp.	kWh/kWh	5,71	5,97	6,79	6,84	6,83	6,69	6,67	6,57	6,76
Unit + option 17 + option 329 Seasonal energy efficiency **		SEER_{12/7°C} Comfort low temp.	kWh/kWh	5,21	5,21	5,44	5,44	5,55	5,44	5,44	5,40	5,56
		ηs cool_{12/7°C}	%	205	205	215	215	219	215	215	213	219
		SEPR_{12/7°C} Process high temp.	kWh/kWh	5,75	6,01	6,88	6,96	6,96	6,79	6,79	6,66	6,87
Sound levels												
Standard unit												
Sound power ⁽¹⁾		dB(A)	95	95	96	98	99	98	99	98	100	
Sound pressure at 10 m ⁽²⁾		dB(A)	63	63	64	65	66	65	67	65	67	
Pression acoustique à 1 m		dB(A)	75	75	76	78	78	77	78	77	78	
Unit + option 15⁽³⁾												
Sound power ⁽¹⁾		dB(A)	94	94	94	96	97	96	97	97	98	
Sound pressure at 10 m ⁽²⁾		dB(A)	62	62	61	64	64	63	65	64	65	
Pression acoustique à 1 m		dB(A)	74	74	74	76	76	75	76	76	76	
Unit + option 15LS⁽³⁾												
Sound power ⁽¹⁾		dB(A)	90	90	90	92	94	92	94	93	94	
Sound pressure at 10 m ⁽²⁾		dB(A)	57	58	58	59	61	60	62	60	61	
Pression acoustique à 1 m		dB(A)	70	70	70	72	73	71	73	72	72	
Dimensions												
Standard unit												
Length		mm	4387	4387	5578	5578	6772	6772	7962	7962	9155	
Width		mm	2261	2261	2261	2261	2261	2261	2261	2261	2261	
Height		mm	2324	2324	2324	2324	2324	2324	2324	2324	2324	
Unit length + options												
Options 49/50 ^{(3) (6)}		mm	5578	5578	6772	6772	6772	6772	7962	7962	9155	
Options 116A/116W ^{(3) (6)}		mm	5578	5578	5578	5578	6772	6772	-	-	-	
Operating weight⁽⁴⁾												
Standard unit		kg	4777	4790	5166	5192	5667	6089	6558	7011	7430	
Unit + option 49 ^{(3) (6)}		kg	5177	5190	5592	5605	5843	6304	6741	7222	7657	
Unit + option 50 ⁽³⁾		kg	5230	5243	5718	5731	5969	6489	6927	7451	7860	
Unit + options 116A/116W ^{(3) (6)}		kg	5291	5405	5592	5618	6223	6644	-	-	-	

- * In accordance with standard EN14511-3:2013.
- ** In accordance with standard EN14825:2016, average climate
- CA1 Cooling mode conditions: Evaporator water entering/leaving temperature 12°C/7°C, outside air temperature 35°C, evaporator frosting factor 0 m².K/W
- ηs cool_{12/7°C} & SEER_{12/7°C}** **Bold values compliant to Ecodesign regulation: (EU) No 2016/2281 for Comfort application**
- SEPR_{12/7°C}** **Bold values compliant to Ecodesign regulation: (EU) No 2016/2281 for Process application**
- (1) In dB ref=10⁻¹² W, 'A' weighted. Declared dual-number noise emission values in accordance with ISO 4871 with an associated uncertainty of +/-3dB(A). Measured in accordance with ISO 9614-1 and certified by Eurovent.
- (2) In dB ref 20μPa, 'A' weighted. Declared dual-number noise emission values in accordance with ISO 4871 with an associated uncertainty of +/-3dB(A). For information, calculated from the sound power Lw(A).
- (3) Options: 15=Low noise level ; 15LS=Very low noise level ; 116A=LP VSD dual-pump hydraulic mod. ; 116W=HP VSD dual-pump hydraulic mod. ; 49=Partial heat recovery ; 50= Totale heat recovery ; 5=Medium Brine ; 6=Low Brine
- (4) Values are guidelines only. Refer to the unit name plate.
- (5) For standard conditions. Depending on operating conditions, unit might have a different minimum capacity or cycle.
- (6) Options 49, 116A, 116W are not available on units 900 to 1300.



Eurovent certified values

PHYSICAL DATA

Standard units - Units 350 - 800 kW

30KAV-ZE		350	400	450	500	550	600	650	750	800
Compressors		Inverter driven 06Z twin screw compressor with AC motor								
Circuit A	Quantity	1	1	1	1	1	1	1	1	1
Circuit B	Quantity	1	1	1	1	1	1	1	1	1
Unit minimum capacity ⁽⁵⁾	%	13	13	13	13	13	13	13	12	12
Refrigerant⁽⁴⁾		R1234ze (GWP=1 following AR5, ODP=0)								
Circuit A	kg	49	50	57	60	67	83	93	87	94
	teqCO ₂	0,30	0,30	0,34	0,36	0,40	0,50	0,56	0,52	0,56
Circuit B	kg	50	51	58	61	68	62	73	88	95
	teqCO ₂	0,30	0,31	0,35	0,36	0,41	0,37	0,44	0,53	0,57
Refrigerant⁽⁴⁾ - Option 5⁽³⁾ (Medium Brine)		R1234ze (GWP=1 following AR5, ODP=0)								
Circuit A	kg	58	60	68	71	82	101	109	105	115
	teqCO ₂	0,35	0,36	0,41	0,43	0,49	0,61	0,65	0,63	0,69
Circuit B	kg	59	61	69	72	83	77	86	106	116
	teqCO ₂	0,35	0,37	0,41	0,43	0,50	0,46	0,52	0,64	0,70
Refrigerant⁽⁴⁾ - Option 6⁽³⁾ (Low Brine)		R1234ze (GWP=1 following AR5, ODP=0)								
Circuit A	kg	52	53	60	63	71	87	98	92	99
	teqCO ₂	0,31	0,32	0,36	0,38	0,42	0,52	0,59	0,55	0,59
Circuit B	kg	53	54	61	64	72	65	77	93	100
	teqCO ₂	0,32	0,32	0,37	0,38	0,43	0,39	0,46	0,56	0,60
Oil		oil for R1234ze. Contact ERCD for supplying								
Circuit A	l	27	26	25	23	20	23	20	23	20
Circuit B	l	27	26	25	23	20	23	20	23	20
Unit control		SmartVu™ with 7 inch coloured touch screen interface								
Languages		10 languages (DE, EN, ES, FR, IT, NL, PT, TR, TU + one on customer choice)								
Smart energy metering		Standard feature								
Wireless connectivity		Option								
Expansion valve		Electronic expansion valve								
Air heat exchanger		Novation™ Micro Channel Heat Exchanger								
Fans		Novation™ Micro Channel Heat Exchanger								
Standard unit		Inverter driven Flying Bird™ VI fans with AC motor								
Unit + option 17		Inverter driven Flying Bird™ VI fans with EC motor								
Quantity		6	6	8	8	10	10	12	12	14
Maximum total air flow	l/s	35580	35580	47440	47440	59300	59300	71160	71160	83020
Maximum rotation speed	r/s	16,0	16,0	16,0	16,0	16,0	16,0	16,0	16,0	16,0
Maximum total air flow + option 15LS ⁽³⁾	l/s	28920	26100	41600	43200	56000	50000	67200	57840	72800
Maximum rotation speed + option 15LS ⁽³⁾	r/s	13,2	12,0	14,2	14,7	15,2	13,7	15,2	13,2	14,2
Water heat exchanger		Flooded shell and tube heat exchanger								
Water volume	l	83	88	96	100	115	126	144	165	183
Max. water-side operating pressure without hydraulic module	kPa	1000	1000	1000	1000	1000	1000	1000	1000	1000
Hydraulic module (option)		Double pump, screen filter, relief valve, water drain valve, pressure sensors, expansion tank (option), heaters (option)								
Pump		Inverter driven dual pumps with AC motor								
Expansion vessel volume	l	80	80	80	80	80	80	-	-	-
Max. water-side operating pressure	kPa	400	400	400	400	400	400	-	-	-
Water connections		Victaulic® type								
Without options 116A/116W⁽³⁾ (6)										
Connections	inch	5	5	6	6	6	6	8	8	8
Outside tube diameter	mm	141,3	141,3	168,3	168,3	168,3	168,3	219,1	219,1	219,1
With options 116A/116W⁽³⁾ (6)										
Connections	inch	5	5	5	5	5	5	-	-	-
Outside tube diameter	mm	141,3	141,3	141,3	141,3	141,3	141,3	-	-	-
Casing paint		Colour code RAL 7035								

(3) Options: 15=Low noise level ; 15LS=Very low noise level ; 116A=LP VSD dual-pump hydraulic mod. ; 116W=HP VSD dual-pump hydraulic mod. ; 49=Partial heat recovery ; 50= Totale heat recovery ; 5=Medium Brine ; 6=Low Brine

(4) Values are guidelines only. Refer to the unit name plate.

(5) For standard conditions. Depending on operating conditions, unit might have a different minimum capacity or cycle.

(6) Options 49, 116A, 116W are not available on units 900 to 1300.

PHYSICAL DATA

Standard units - Units 900 - 1300 kW

30KAV-ZE		900	1000	1100	1200	1300		
Cooling								
Standard unit Full load performances*	CA1	Nominal capacity	kW	941	1036	1146	1257	1354
		EER	kW/kW	3,15	3,22	3,31	3,27	3,01
Standard unit Seasonal energy efficiency **		SEER_{12/7°C} Comfort low temp.	kWh/kWh	5,34	5,43	5,49	5,51	5,41
		ηs cool_{12/7°C}	%	211	214	216	217	213
		SEPR_{12/7°C} Process high temp.	kWh/kWh	6,23	6,29	6,40	6,30	6,14
Unit + option 17 Seasonal energy efficiency **		SEER_{12/7°C} Comfort low temp.	kWh/kWh	5,48	5,58	5,63	5,65	5,54
		ηs cool_{12/7°C}	%	216	220	222	223	219
		SEPR_{12/7°C} Process high temp.	kWh/kWh	6,38	6,45	6,55	6,44	6,28
Unit + option 329 Seasonal energy efficiency **		SEER_{12/7°C} Comfort low temp.	kWh/kWh	-	-	-	-	-
		ηs cool_{12/7°C}	%	-	-	-	-	-
		SEPR_{12/7°C} Process high temp.	kWh/kWh	-	-	-	-	-
Unit + option 17 + option 329 Seasonal energy efficiency **		SEER_{12/7°C} Comfort low temp.	kWh/kWh	-	-	-	-	-
		ηs cool_{12/7°C}	%	-	-	-	-	-
		SEPR_{12/7°C} Process high temp.	kWh/kWh	-	-	-	-	-
Sound levels								
Standard unit								
Sound power ⁽¹⁾		dB(A)	100	102	100	103	104	
Sound pressure at 10 m ⁽²⁾		dB(A)	67	69	67	69	71	
Pression acoustique à 1 m		dB(A)	78	80	78	80	81	
Unit + option 15⁽³⁾								
Sound power ⁽¹⁾		dB(A)	98	100	98	100	99	
Sound pressure at 10 m ⁽²⁾		dB(A)	65	67	65	67	66	
Pression acoustique à 1 m		dB(A)	76	78	75	77	76	
Unit + option 15LS⁽³⁾								
Sound power ⁽¹⁾		dB(A)	96	96	97	98	98	
Sound pressure at 10 m ⁽²⁾		dB(A)	63	74	64	65	65	
Pression acoustique à 1 m		dB(A)	74	74	75	75	75	
Dimensions								
Standard unit								
Length		mm	9157	10347	11541	12731	12731	
Width		mm	2261	2261	2261	2261	2261	
Height		mm	2324	2324	2324	2324	2324	
Unit length + options								
Options 49/50 ^{(3) (6)}		mm	10347	10347	11541	12731	12731	
Options 116A/116W ^{(3) (6)}		mm	-	-	-	-	-	
Operating weight⁽⁴⁾								
Standard unit		kg	8760	9241	9880	10267	10318	
Unit + option 49 ^{(3) (6)}		kg	-	-	-	-	-	
Unit + option 50 ⁽³⁾		kg	9603	9902	10534	10961	11040	
Unit + options 116A/116W ^{(3) (6)}		kg	-	-	-	-	-	

- * In accordance with standard EN14511-3:2013.
- ** In accordance with standard EN14825:2016, average climate
- CA1 Cooling mode conditions: Evaporator water entering/leaving temperature 12°C/7°C, outside air temperature 35°C, evaporator frosting factor 0 m².K/W
- ηs cool_{12/7°C} & SEER_{12/7°C}** **Bold values compliant to Ecodesign regulation: (EU) No 2016/2281 for Comfort application**
- SEPR_{12/7°C}** **Bold values compliant to Ecodesign regulation: (EU) No 2016/2281 for Process application**
- (1) In dB ref=10⁻¹² W, 'A' weighted. Declared dual-number noise emission values in accordance with ISO 4871 with an associated uncertainty of +/-3dB(A). Measured in accordance with ISO 9614-1 and certified by Eurovent.
- (2) In dB ref 20μPa, 'A' weighted. Declared dual-number noise emission values in accordance with ISO 4871 with an associated uncertainty of +/-3dB(A). For information, calculated from the sound power Lw(A).
- (3) Options: 15=Low noise level ; 15LS=Very low noise level ; 116A=LP VSD dual-pump hydraulic mod. ; 116W=HP VSD dual-pump hydraulic mod. ; 49=Partial heat recovery ; 50= Totale heat recovery ; 5=Medium Brine ; 6=Low Brine
- (4) Values are guidelines only. Refer to the unit name plate.
- (5) For standard conditions. Depending on operating conditions, unit might have a different minimum capacity or cycle.
- (6) Options 49, 116A, 116W are not available on units 900 to 1300.



Eurovent certified values

PHYSICAL DATA

Standard units - Units 900 - 1300 kW

30KAV-ZE		900	1000	1100	1200	1300
Compressors		Inverter driven 06Z twin screw compressor with AC motor				
Circuit A	Quantity	1	1	1	1	1
Circuit B	Quantity	1	1	1	1	1
Unit minimum capacity ⁽⁵⁾	%	15	14	13	12	10
Refrigerant⁽⁴⁾		R1234ze (GWP=1 following AR5, ODP=0)				
Circuit A	kg	108	119	128	135	139
	teqCO ₂	0,65	0,71	0,77	0,81	0,83
Circuit B	kg	107	118	126	133	137
	teqCO ₂	0,64	0,71	0,76	0,80	0,82
Refrigerant⁽⁴⁾ - Option 5⁽³⁾ (Medium Brine)		R1234ze (GWP=1 following AR5, ODP=0)				
Circuit A	kg	124	137	147	155	160
	teqCO ₂	0,74	0,82	0,88	0,93	0,96
Circuit B	kg	123	136	145	153	158
	teqCO ₂	0,74	0,82	0,87	0,92	0,95
Refrigerant⁽⁴⁾ - Option 6⁽³⁾ (Low Brine)		R1234ze (GWP=1 following AR5, ODP=0)				
Circuit A	kg	113	125	134	142	146
	teqCO ₂	0,68	0,75	0,80	0,85	0,88
Circuit B	kg	112	124	132	140	144
	teqCO ₂	0,67	0,74	0,79	0,84	0,86
Oil		oil for R1234ze. Contact ERCD for supplying				
Circuit A	l	30	30	30	30	30
Circuit B	l	30	30	30	30	30
Unit control		SmartVu™ with 7 inch coloured touch screen interface				
Languages		10 languages (DE, EN, ES, FR, IT, NL, PT, TR, TU + one on customer choice)				
Smart energy metering		Standard feature				
Wireless connectivity		Option				
Expansion valve		Electronic expansion valve				
Air heat exchanger		Novation™ Micro Channel Heat Exchanger				
Fans		Novation™ Micro Channel Heat Exchanger				
Standard unit		Inverter driven Flying Bird™ VI fans with AC motor				
Unit + option 17		Inverter driven Flying Bird™ VI fans with EC motor				
Quantity		14	16	18	20	20
Maximum total air flow	l/s	83020	94880	106740	118600	118600
Maximum rotation speed	r/s	16,0	16,0	16,0	16,0	16,0
Maximum total air flow + option 15LS ⁽³⁾	l/s	74200	84800	95400	106000	106000
Maximum rotation speed + option 15LS ⁽³⁾	r/s	14,4	14,4	14,4	14,4	14,4
Water heat exchanger		Flooded shell and tube heat exchanger				
Water volume	l	178	224	243	261	270
Max. water-side operating pressure without hydraulic module	kPa	1000	1000	1000	1000	1000
Water connections		Victaulic® type				
Without options 116A/116W⁽³⁾ (6)						
Connections	inch	8	8	8	8	8
Outside tube diameter	mm	219,1	219,1	219,1	219,1	219,1
Casing paint		Colour code RAL 7035				

(3) Options: 15=Low noise level ; 15LS=Very low noise level ; 116A=LP VSD dual-pump hydraulic mod. ; 116W=HP VSD dual-pump hydraulic mod.; 49=Partial heat recovery ; 50= Totale heat recovery ; 5=Medium Brine ; 6=Low Brine

(4) Values are guidelines only. Refer to the unit name plate.

(5) For standard conditions. Depending on operating conditions, unit might have a different minimum capacity or cycle.

(6) Options 49, 116A, 116W are not available on units 900 to 1300.

PHYSICAL DATA

30KAV-ZE option 119 and 30KAVPZE

30KAV-ZE options 119		350	400	450	500	550	600	650	750	800	900	1000	1100			
Cooling																
Unit + option 119 + 17 Full load performances*	CA1	Nominal capacity	kW		380	421	467	491	541	625	684	773	836	956	1051	1155
		EER	kW/kW		3,53	3,53	3,40	3,32	3,33	3,45	3,36	3,43	3,39	3,42	3,46	3,46
Unit + option 119 Seasonal energy efficiency **		SEER_{12/7°C} Comfort	kWh/kWh		5,39	5,33	5,47	5,43	5,48	5,45	5,35	5,36	5,36	5,59	5,66	5,60
		$\eta_{s\ cool\ 12/7°C}$	%		213	210	216	214	216	215	211	211	211	221	224	221
		SEPR_{12/7°C} Process	kWh/kWh		6,01	6,79	6,69	6,84	6,55	6,75	6,56	6,55	6,57	6,56	6,59	6,51
Unit + option 119 + 17 Seasonal energy efficiency **		SEER_{12/7°C} Comfort	kWh/kWh		5,44	5,44	5,53	5,51	5,55	5,51	5,43	5,43	5,45	5,74	5,82	5,75
		$\eta_{s\ cool\ 12/7°C}$	%		215	215	218	217	219	217	214	214	215	227	230	227
		SEPR_{12/7°C} Process	kWh/kWh		6,03	6,88	6,76	6,95	6,65	6,82	6,67	6,63	6,68	6,73	6,75	6,66
30KAVPZE		350	400	450	500	550	600	650	750	800						
Standard unit Full load performances*	CA1	Nominal capacity	kW		380	421	467	491	541	625	684	773	836			
		EER	kW/kW		3,57	3,56	3,43	3,36	3,36	3,48	3,40	3,47	3,42			
Standard unit Seasonal energy efficiency **		SEER_{12/7°C} Comfort	kWh/kWh		5,59	5,60	5,69	5,68	5,71	5,67	5,59	5,59	5,61			
		$\eta_{s\ cool\ 12/7°C}$	%		221	221	225	224	225	224	221	221	221			
		SEPR_{12/7°C} Process	kWh/kWh		6,38	7,10	7,05	7,18	6,89	7,01	6,84	6,83	6,85			
30KAV-ZE option 119 & 30KAVPZE (7) (8)		350	400	450	500	550	600	650	750	800	900	1000	1100			
Sound levels																
Unit																
Sound power ⁽¹⁾	dB(A)		96	96	97	98	99	98	100	98	100	100	102	100		
Sound pressure at 10 m ⁽²⁾	dB(A)		63	63	64	66	66	65	67	65	67	67	69	67		
Pression acoustique à 1 m	dB(A)		76	76	76	78	78	77	78	77	78	78	79	77		
Unit + option 15⁽³⁾																
Sound power ⁽¹⁾	dB(A)		95	95	94	96	97	96	98	98	98	98	100	98		
Sound pressure at 10 m ⁽²⁾	dB(A)		62	62	62	64	64	64	65	65	65	65	67	65		
Pression acoustique à 1 m	dB(A)		75	75	74	76	76	76	76	76	76	76	77	75		
Unit + option 15LS⁽³⁾																
Sound power ⁽¹⁾	dB(A)		90	91	91	92	94	92	94	93	94	96	97	97		
Sound pressure at 10 m ⁽²⁾	dB(A)		57	58	58	59	61	60	61	60	61	63	63	64		
Pression acoustique à 1 m	dB(A)		70	70	70	72	73	71	72	71	72	74	74	74		
Dimensions																
Unit																
Length	mm		6772	6772	6772	6772	7962	9155	9120	10346	10346	11541	12731	12731		
Width	mm		2261	2261	2261	2261	2261	2261	2261	2261	2261	2261	2261	2261		
Height	mm		2324	2324	2324	2324	2324	2324	2324	2324	2324	2324	2324	2324		
Unit length + options																
Options 49/50 ^{(3) (6)}	mm		6772	6772	6772	6772	7962	9155	9120	10346	10346	11541	12731	12731		
Options 116A/116W ^{(3) (6)}	mm		6772	6772	6772	6772	7962	9155	-	-	-	-	-	-		

- * In accordance with standard EN14511-3:2018.
 ** In accordance with standard EN14825:2016, average climate
 *** With EG 30%
 CA1 Cooling mode conditions: Evaporator water entering/leaving temperature 12°C/7°C, outside air temperature 35°C, evaporator frosting factor 0 m².K/W
 $\eta_{s\ cool\ 12/7°C}$ & SEER_{12/7°C} SEPR_{12/7°C} Bold values compliant to Ecodesign regulation: (EU) No 2016/2281 for Comfort application
Bold values compliant to Ecodesign regulation: (EU) No 2016/2281 for Process application
 (1) In dB ref=10⁻¹² W, 'A' weighted. Declared dual-number noise emission values in accordance with ISO 4871 with an associated uncertainty of +/-3dB(A). Measured in accordance with ISO 9614-1 and certified by Eurovent.
 (2) In dB ref=20µPa, 'A' weighted. Declared dual-number noise emission values in accordance with ISO 4871 with an associated uncertainty of +/-3dB(A). For information, calculated from the sound power Lw(A).
 (3) Options: 15=Low noise level ; 15LS=Very low noise level ; 116A=LP VSD dual-pump hydraulic mod. ; 116W=HP VSD dual-pump hydraulic mod. ; 49=Partial heat recovery ; 50= Totale heat recovery ; 5=Medium Brine ; 6=Low Brine
 (6) Options 49, 116A, 116W are not available on units 900 to 1300.
 (7) Option 119 is not available with 30KAV-ZE 1200 and 1300.
 (8) 30KAVPZE premium version is not available with units 900, 1000, 1100, 1200, 1300.



Eurovent certified values

PHYSICAL DATA

30KAV-ZE option 119 and 30KAVPZE

30KAV-ZE option 119 & 30KAVPZE ^{(7) (8)}		350	400	450	500	550	600	650	750	800	900	1000	1100
Operating weight⁽⁴⁾													
Unit	kg	5490	5503	5523	5530	5972	6780	6906	7679	7726	9473	9942	10193
Unit + option 49 ^{(3) (6)}	kg	5704	5717	5737	5744	6183	7013	7139	7928	7975	-	-	-
Unit + option 50 ⁽³⁾	kg	5779	5792	5925	5932	6371	7257	7383	8231	8278	10127	10591	10842
options 116A/116W ^{(3) (6)}	kg	5941	6055	6043	6069	6029	7470	-	-	-	-	-	-
Compressors Inverter driven 06Z twin screw compressor. 30KAV-ZE : AC motor. 30KAVPZE : permanent magnet motor.													
Circuit A	Quantity	1	1	1	1	1	1	1	1	1	1	1	1
Circuit B	Quantity	1	1	1	1	1	1	1	1	1	1	1	1
Unit minimum capacity ⁽⁵⁾	%	13	13	13	13	13	13	13	12	12	15	14	13
Refrigerant⁽⁴⁾ R1234ze (GWP=1 following AR5, ODP=0)													
Circuit A	kg	67	67	68	66	74	96	100	100	101	122	133	135
	teqCO ₂	0,40	0,40	0,41	0,40	0,44	0,58	0,60	0,60	0,60	0,73	0,80	0,81
Circuit B	kg	68	68	68	67	75	75	80	101	102	121	132	133
	teqCO ₂	0,41	0,41	0,41	0,40	0,45	0,45	0,48	0,60	0,61	0,73	0,79	0,80
Refrigerant⁽⁴⁾ - Option 5⁽³⁾ (Medium Brine) R1234ze (GWP=1 following AR5, ODP=0)													
Circuit A	kg	76	77	79	77	87	114	116	118	122	138	151	154
	teqCO ₂	0	0	0	0	1	1	1	1	1	0,83	0,91	0,92
Circuit B	kg	77	78	79	78	88	90	93	119	123	137	150	152
	teqCO ₂	0	0	0	0	1	1	1	1	1	0,82	0,90	0,91
Refrigerant⁽⁴⁾ - Option 6⁽³⁾ (Low Brine) R1234ze (GWP=1 following AR5, ODP=0)													
Circuit A	kg	70	70	71	69	78	101	105	105	106	127	139	141
	teqCO ₂	0	0	0	0	0	1	1	1	1	0,76	0,83	0,85
Circuit B	kg	71	71	71	70	79	79	84	106	107	126	138	139
	teqCO ₂	0	0	0	0	0	0	1	1	1	0,76	0,83	0,83
Oil oil for R1234ze. Contact ERCD for supplying													
Circuit A	l	27	26	25	23	20	23	20	23	20	30	30	30
Circuit B	l	27	26	25	23	20	23	20	23	20	30	30	30
Unit control SmartVu™ with 7 inch colored touch screen interface													
Languages	10 languages (DE, EN, ES, FR, IT, NL, PT, TR, TU + one on customer choice)												
Smart energy metering	Standard feature												
Wireless connectivity	Option												
Expansion valve Electronic expansion valve													
Air heat exchanger Novation™ Micro Channel Heat Exchanger													
Fans Inverter driven Flying Bird™ VI fans with AC motor													
Units 30KAV-ZE_option 119 ⁽⁷⁾ Inverter driven Flying Bird™ VI fans with EC motor													
Units 30KAVPZE ⁽⁸⁾													
Quantity		10	10	10	10	12	14	14	16	16	18	20	20
Maximum total air flow	l/s	59300	59300	59300	59300	71160	83020	83020	94880	94880	106740	118600	118600
Maximum rotation speed	r/s	16,0	16,0	16,0	16,0	16,0	16,0	16,0	16,0	16,0	16	16	16
Maximum total air flow + option 15LS ⁽³⁾	l/s	44700	43500	52000	52000	64800	67480	75600	74080	83200	95220	105800	105800
Maximum rotation speed + option 15LS ⁽³⁾	r/s	12,3	12	14,2	14,2	14,7	13,2	14,7	12,7	14,2	14,4	14,4	14,4
Water heat exchanger Flooded shell and tube heat exchanger													
Water volume	l	83	88	96	100	115	126	144	165	183	0	0	0
Max. water-side operating pressure without hydraulic module	kPa	1000	1000	1000	1000	1000	1000	1000	1000	1000	1000	1000	1000
Hydraulic module (option) Double pump, screen filter, relief valve, water drain valve, pressure sensors, expansion tank (option), heaters (option)													
Pump Inverter driven dual pumps with AC motor													
Expansion vessel volume	l	80	80	80	80	80	80	-	-	-	-	-	-
Max. water-side operating pressure	kPa	400	400	400	400	400	400	-	-	-	-	-	-
Water connections Victaulic® type													
Without options 116A/116W^{(3) (6)}													
Connections	inch	5	5	6	6	6	6	8	8	8	8	8	8
Outside tube diameter	mm	141,3	141,3	168,3	168,3	168,3	168,3	219,1	219,1	219,1	219,1	219,1	219,1
With options 116A/116W^{(3) (6)}													
Connections	inch	5	5	5	5	5	5	-	-	-	-	-	-
Outside tube diameter	mm	141,3	141,3	141,3	141,3	141,3	141,3	-	-	-	-	-	-
Casing paint Colour code RAL 7035													

(3) Options: 15=Low noise level ; 15LS=Very low noise level ; 116A=LP VSD dual-pump hydraulic mod. ; 116W=HP VSD dual-pump hydraulic mod. ; 49=Partial heat recovery ; 50= Totale heat recovery ; 5=Medium Brine ; 6=Low Brine

(4) Values are guidelines only. Refer to the unit name plate.

(5) For standard conditions. Depending on operating conditions, unit might have a different minimum capacity or cycle.

(6) Options 49, 116A, 116W are not available on units 900 to 1300.

(7) Option 119 is not available with 30KAV-ZE 1200 and 1300.

(8) 30KAVPZE premium version is not available with units 900, 1000, 1100, 1200, 1300.

PHYSICAL DATA

30KAVIZE

30KAVIZE		500	800	1100	1250		
Cooling							
Standard unit Full load performances*	CA1	Nominal capacity	kW	532	781	1120	1307
		EER	kW/kW	2,79	2,85	3,02	2,59
	***	Nominal capacity	kW	283	454	682	804
		EER	kW/kW	1,83	1,82	2,05	1,90
Standard unit Seasonal energy efficiency **		SEER _{12/7°C} Comfort low temp.	kWh/kWh	4,73	5,00	5,22	5,02
		ηs cool _{12/7°C}	%	186	197	206	198
		SEPR _{12/7°C} Process high temp.	kWh/kWh	5,62	6,03	5,95	5,55
		SEPR _{-2/-8°C} Process medium temp.	kWh/kWh	3,55	3,61	3,74	3,57
Unit + option 17 Seasonal energy efficiency **		SEER _{12/7°C} Comfort low temp.	kWh/kWh	4,84	5,14	5,35	5,13
		ηs cool _{12/7°C}	%	191	202	211	202
		SEPR _{12/7°C} Process high temp.	kWh/kWh	5,75	6,20	6,08	5,66
		SEPR _{-2/-8°C} Process medium temp.	kWh/kWh	3,61	3,68	3,82	3,64
Unit + option 329 Seasonal energy efficiency **		SEER _{12/7°C} Comfort low temp.	kWh/kWh	4,90	5,22	-	-
		ηs cool _{12/7°C}	%	193	206	-	-
		SEPR _{12/7°C} Process high temp.	kWh/kWh	5,73	6,18	-	-
		SEPR _{-2/-8°C} Process medium temp.	kWh/kWh	3,62	3,69	-	-
Unit + option 17 + option 329 Seasonal energy efficiency **		SEER _{12/7°C} Comfort low temp.	kWh/kWh	5,02	5,36	-	-
		ηs cool _{12/7°C}	%	198	211	-	-
		SEPR _{12/7°C} Process high temp.	kWh/kWh	5,87	6,35	-	-
		SEPR _{-2/-8°C} Process medium temp.	kWh/kWh	3,69	3,77	-	-
Sound levels							
Standard unit							
Sound power ⁽¹⁾		dB(A)		102	103	101	105
Sound pressure at 10 m ⁽²⁾		dB(A)		70	70	68	72
Pression acoustique à 1 m		dB(A)		82	82	79	83
Unit + option 15⁽³⁾							
Sound power ⁽¹⁾		dB(A)		98	100	98	101
Sound pressure at 10 m ⁽²⁾		dB(A)		66	67	65	68
Pression acoustique à 1 m		dB(A)		78	79	76	79
Unit + option 15LS⁽³⁾							
Sound power ⁽¹⁾		dB(A)		94	95	97	99
Sound pressure at 10 m ⁽²⁾		dB(A)		62	62	64	66
Pression acoustique à 1 m		dB(A)		74	74	75	77

* In accordance with standard EN14511-3:2013.

** In accordance with standard EN14825:2016, average climate

*** Cooling mode conditions: Evaporator with turbulators (option Brine 6), MEG 30%, entering/leaving temperature -4°C/8°C, outside air temperature 35°C, evaporator fooling factor 0 m².K/W

CA1 Cooling mode conditions: Evaporator water entering/leaving temperature 12°C/7°C, outside air temperature 35°C, evaporator fooling factor 0 m².K/W

ηs cool _{12/7°C} & **SEER** _{12/7°C} **Bold values compliant to Ecodesign regulation: (EU) No 2016/2281 for Comfort application**

SEPR _{12/7°C} **Bold values compliant to Ecodesign regulation: (EU) No 2016/2281 for Process application**

SEPR _{-2/-8°C} **Bold values compliant to Ecodesign regulation: (EU) No 2016/2281 for Process application**

(1) In dB ref=10⁻¹² W, 'A' weighted. Declared dual-number noise emission values in accordance with ISO 4871 with an associated uncertainty of +/-3dB(A). Measured in accordance with ISO 9614-1 and certified by Eurovent.

(2) In dB ref 20μPa, 'A' weighted. Declared dual-number noise emission values in accordance with ISO 4871 with an associated uncertainty of +/-3dB(A). For information, calculated from the sound power Lw(A).

(3) Options: 15=Low noise level ; 15LS=Very low noise level ; 116A=LP VSD dual-pump hydraulic mod. ; 116W=HP VSD dual-pump hydraulic mod. ; 49=Partial heat recovery ; 50= Totale heat recovery ; 5=Medium Brine ; 6=Low Brine.



Eurovent certified values

PHYSICAL DATA

30KAVIZE		500	800	1100	1250
Dimensions					
Standard unit					
Length	mm	4350	6735	9157	9157
Width	mm	2261	2261	2261	2261
Height	mm	2324	2324	2324	2324
Unit length + options					
Options 50 ⁽³⁾	mm	5540	6735	10347	10347
Operating weight⁽⁴⁾					
Standard unit	kg	4877	6679	9143	9266
Option 50 ⁽³⁾	kg	5473	7242	9986	10200
Compressors					
Inverter driven 06Z twin screw compressor with AC motor					
Circuit A	Quantity	1	1	1	1
Circuit B	Quantity	1	1	1	1
Unit minimum capacity ⁽⁵⁾	%	13	12	13	10
Refrigerant⁽⁴⁾					
R1234ze (GWP=1 following AR5, ODP=0)					
Circuit A	kg	54	80	114	118
	teqCO ₂	0,32	0,48	0,68	0,71
Circuit B	kg	55	81	112	116
	teqCO ₂	0,33	0,49	0,67	0,70
Refrigerant⁽⁴⁾ - Option 5⁽³⁾ (Medium Brine)					
R1234ze (GWP=1 following AR5, ODP=0)					
Circuit A	kg	67	101	131	136
	teqCO ₂	0,40	0,61	0,79	0,82
Circuit B	kg	68	102	129	133
	teqCO ₂	0,41	0,61	0,77	0,80
Refrigerant⁽⁴⁾ - Option 6⁽³⁾ (Low Brine)					
R1234ze (GWP=1 following AR5, ODP=0)					
Circuit A	kg	57	84	120	124
	teqCO ₂	0,34	0,50	0,72	0,74
Circuit B	kg	58	85	118	122
	teqCO ₂	0,35	0,51	0,71	0,73
Oil					
Oil for R1234ze. Contact ERCD for supplying					
Circuit A	l	23	20	30	30
Circuit B	l	23	20	30	30
Unit control					
SmartVu™ with 7 inch coloured touch screen interface					
Languages	10 languages (DE, EN, ES, FR, IT, NL, PT, TR, TU + one on customer choice)				
Smart energy metering	Standard feature				
Wireless connectivity	Option				
Expansion valve					
Electronic expansion valve					
Air heat exchanger					
Novation™ Micro Channel Heat Exchanger					
Fans					
Novation™ Micro Channel Heat Exchanger					
Standard unit					
Inverter driven Flying Bird™ VI fans with AC motor					
Unit + option 17					
Inverter driven Flying Bird™ VI fans with EC motor					
Quantity		3	5	7	7
Maximum total air flow	l/s	17790	29650	41510	41510
Maximum rotation speed	r/s	16,0	16,0	16,0	16,0
Maximum total air flow + option 15LS ⁽³⁾	l/s	15900	26500	37100	37100
Maximum rotation speed + option 15LS ⁽³⁾	r/s	14,4	14,4	14,4	14,4
Water heat exchanger					
Flooded shell and tube heat exchanger					
Water volume	l	115	183	243	270
Max. water-side operating pressure without hydraulic module	kPa	1000	1000	1000	1000
Water connections					
Victaulic® type					
Connections	inch	6	8	8	8
Outside tube diameter	mm	168,3	219,1	219,1	219,1
Casing paint					
Colour code RAL 7035					

(3) Options: 15=Low noise level ; 15LS=Very low noise level ; 116A=LP VSD dual-pump hydraulic mod. ; 116W=HP VSD dual-pump hydraulic mod.; 49=Partial heat recovery ; 50= Totale heat recovery ; 5=Medium Brine ; 6=Low Brine

(4) Values are guidelines only. Refer to the unit name plate.

(5) For standard conditions. Depending on operating conditions, unit might have a different minimum capacity or cycle

ELECTRICAL DATA

Standard units

30KAV-ZE		350	400	450	500	550	600	650	750	800	900	1000	1100	1200	1300
Power circuit supply															
Nominal voltage	V-ph-Hz	400-3-50													
Voltage range	V	360-440													
Control circuit supply		24 V via internal transformer													
Maximum operating input power⁽¹⁾															
Standard unit	kW	180	196	214	232	257	293	325	366	393	418	459	499	550	608
Unit + option 16	kW	194	211	229	248	275	311	353	386	431	443	487	529	580	640
Power factor at maximum power^{(1) (2)}		0,91-0,93													
Displacement Power Factor (Cos Phi)		>0,98													
Total harmonic distortion (THDi) ^{(1) (3)}		35-45													
Maximum operating current draw (Un)⁽¹⁾															
Standard unit	A	280	305	332	360	400	456	505	568	610	649	713	775	854	945
Unit + option 16	A	301	328	355	385	428	484	548	599	669	689	756	822	902	995
Maximum operating current draw (Un-10%)⁽¹⁾															
Standard unit	A	306	332	362	383	426	494	537	604	649	709	778	825	919	1006
Unit + option 16	A	329	357	388	410	455	524	583	638	712	753	825	874	971	1060
Start-up current															
Standard unit	A	180	192	206	220	240	314	341	334	335	399	430	461	535	544

(1) Values obtained at operation with maximum operating power input (data given on the unit nameplate)

(2) Value decreases when load lowers

(3) May vary according to the installation's short circuit ratio

THDi increases when load lowers. But the highest impact on the installation occurs when the current is maximum. Therefore compliance of the installation regarding voltage harmonic distortion at PCC (per IEC61000-2-4 or other standard) shall be usually checked at max load in order to cover all load conditions

ELECTRICAL DATA

Electrical data - Units with combination of options High energy efficiency (119), Permanent magnet motor (329), EC motor (17)

Units 350 - 800 kW

30KAV-ZE + options 119		350	400	450	500	550	600	650	750	800
Power circuit supply										
Nominal voltage	V-ph-Hz	400-3-50								
Voltage range	V	360-440								
Control circuit supply										
24 V via internal transformer										
Maximum unit power input⁽¹⁾										
Unit + option 119	kW	181	200	209	226	250	288	315	358	380
Unit + option 119 + option 17	kW	179	198	206	223	247	285	311	354	375
Unit + option 119 + option 16	kW	195	215	224	242	268	306	343	378	418
Unit + option 119 + option 17 + option 16	kW	193	213	221	239	265	303	339	374	413
Unit + option 329	kW	169	185	202	219	248	272	313	337	378
Unit + option 329 + option 16	kW	175	193	209	227	258	282	325	350	392
Unit + option 329 + option 119	kW	170	189	197	213	241	267	303	329	365
Unit + option 329 + option 119 + option 16	kW	176	306	316	342	390	432	489	531	588
Maximum capacity power factor^{(1) (2)}										
0,91-0,93										
Displacement Power Factor (Cos Phi)										
>0,98										
Total harmonic distortion (THDi) ^{(1) (3)}										
%										
35-45										
Maximum unit current draw (Un)⁽¹⁾										
Unit + option 119	A	281	311	324	350	389	449	489	556	590
Unit + option 119 + option 17	A	278	308	320	346	384	444	483	550	583
Unit + option 119 + option 16	A	302	334	347	375	417	477	532	587	649
Unit + option 119 + option 17 + option 16	A	299	331	343	371	412	472	526	581	642
Unit + option 329	A	263	288	313	340	386	423	486	523	587
Unit + option 329 + option 16	A	273	300	324	352	401	439	505	543	608
Unit + option 329 + option 119	A	264	294	305	330	375	416	470	511	567
Unit + option 329 + option 119 + option 16	A	274	306	316	342	390	432	489	531	588
Maximum unit current draw (Un-10%)⁽¹⁾										
Unit + option 119	A	306	331	353	367	413	485	520	591	635
Unit + option 119 + option 17	A	303	328	349	363	408	480	514	585	628
Unit + option 119 + option 16	A	329	356	379	394	442	515	566	625	698
Unit + option 119 + option 17 + option 16	A	326	353	375	390	437	510	560	619	691
Unit + option 329	A	289	315	343	363	412	461	518	559	626
Unit + option 329 + option 16	A	300	327	356	376	428	479	539	580	641
Unit + option 329 + option 119	A	289	314	334	347	399	452	501	546	612
Unit + option 329 + option 119 + option 16	A	300	326	347	360	415	470	522	567	627
Start-up current										
Unit + option 119	A	175	189	199	212	226	296	319	314	330
Unit + option 119 + option 17	A	174	187	197	210	224	294	316	311	326
Unit + option 329	A	160	168	191	205	223	278	316	293	327

(1) Values obtained at operation with maximum operating power input (data given on the unit nameplate)

(2) Value decreases when load lowers

(3) May vary according to the installation's short circuit ratio

THDi increases when load lowers. But the highest impact on the installation occurs when the current is maximum. Therefore compliance of the installation regarding voltage harmonic distortion at PCC (per IEC61000-2-4 or other standard) shall be usually checked at max load in order to cover all load conditions.

ELECTRICAL DATA

Electrical data - Units with combination of options High energy efficiency (119), Permanent magnet motor (329), EC motor (17)

Units 900 - 1300 kW

30KAV-ZE + options 119		900	1000	1100	1200	1300
Power circuit supply						
Nominal voltage	V-ph-Hz	400-3-50				
Voltage range	V	360-440				
Control circuit supply						
24 V via internal transformer						
Maximum unit power input⁽¹⁾						
Unit + option 119	kW	408	447	480	-	-
Unit + option 119 + option 17	kW	403	442	475	-	-
Unit + option 119 + option 16	kW	434	475	510	-	-
Unit + option 119 + option 17 + option 16	kW	429	470	505	-	-
Unit + option 329	kW	-	-	-	-	-
Unit + option 329 + option 16	kW	-	-	-	-	-
Unit + option 329 + option 119	kW	-	-	-	-	-
Unit + option 329 + option 119 + option 16	kW	-	-	-	-	-
Maximum capacity power factor^{(1) (2)}						
0,91-0,93						
Displacement Power Factor (Cos Phi)						
>0,98						
Total harmonic distortion (THDi) ^{(1) (3)}						
35-45						
Maximum unit current draw (Un)⁽¹⁾						
Unit + option 119	A	634	694	746	-	-
Unit + option 119 + option 17	A	627	687	738	-	-
Unit + option 119 + option 16	A	674	737	793	-	-
Unit + option 119 + option 17 + option 16	A	667	730	785	-	-
Unit + option 329	A	-	-	-	-	-
Unit + option 329 + option 16	A	-	-	-	-	-
Unit + option 329 + option 119	A	-	-	-	-	-
Unit + option 329 + option 119 + option 16	A	-	-	-	-	-
Maximum unit current draw (Un-10%)⁽¹⁾						
Unit + option 119	A	691	756	794	-	-
Unit + option 119 + option 17	A	684	749	786	-	-
Unit + option 119 + option 16	A	735	803	843	-	-
Unit + option 119 + option 17 + option 16	A	728	796	835	-	-
Unit + option 329	A	-	-	-	-	-
Unit + option 329 + option 16	A	-	-	-	-	-
Unit + option 329 + option 119	A	-	-	-	-	-
Unit + option 329 + option 119 + option 16	A	-	-	-	-	-
Start-up current						
Unit + option 119	A	391	420	446	-	-
Unit + option 119 + option 17	A	388	417	442	-	-
Unit + option 329	A	-	-	-	-	-

(1) Values obtained at operation with maximum operating power input (data given on the unit nameplate)

(2) Value decreases when load lowers

(3) May vary according to the installation's short circuit ratio

THDi increases when load lowers. But the highest impact on the installation occurs when the current is maximum. Therefore compliance of the installation regarding voltage harmonic distortion at PCC (per IEC61000-2-4 or other standard) shall be usually checked at max load in order to cover all load conditions.

ELECTRICAL DATA

30KAVPZE

30KAVPZE		350	400	450	500	550	600	650	750	800
Power circuit supply										
Nominal voltage	V-ph-Hz	400-3-50								
Voltage range	V	360-440								
Control circuit supply										
24 V via internal transformer										
Maximum operating input power⁽¹⁾										
Standard unit	kW	168	187	194	210	238	264	299	325	360
Unit + option 16	kW	174	195	201	218	248	274	311	338	374
Power factor at maximum power ^{(1) (2)}										
0,91-0,93										
Displacement Power Factor (Cos Phi)										
>0,98										
Total harmonic distortion (THDi) ^{(1) (3)}										
%										
35-45										
Maximum operating current draw (Un)⁽¹⁾										
Standard unit	A	261	291	301	326	370	411	464	505	560
Unit + option 16	A	271	303	312	338	385	427	483	525	581
Maximum operating current draw (Un-10%)⁽¹⁾										
Standard unit	A	286	311	330	343	394	447	495	540	605
Unit + option 16	A	309	336	356	370	423	477	541	574	668
Start-up current										
Standard unit		173	188	193	206	228	287	320	306	334

(1) Values obtained at operation with maximum operating power input (data given on the unit nameplate)

(2) Value decreases when load lowers

(3) May vary according to the installation's short circuit ratio

THDi increases when load lowers. But the highest impact on the installation occurs when the current is maximum. Therefore compliance of the installation regarding voltage harmonic distortion at PCC (per IEC61000-2-4 or other standard) shall be usually checked at max load in order to cover all load conditions.

30KAVIZE

30KAVIZE		500	800	1100	1250
Power circuit supply					
Nominal voltage	V-ph-Hz	400-3-50			
Voltage range	V	360-440			
Control circuit supply					
24 V via internal transformer					
Maximum operating input power⁽¹⁾					
Standard unit	kW	266	421	520	626
Power factor at maximum power ^{(1) (2)}					
0,91-0,93					
Displacement Power Factor (Cos Phi)					
>0,98					
Total harmonic distortion (THDi) ^{(1) (3)}					
%					
35-45					
Maximum operating current draw (Un)⁽¹⁾					
Standard unit	A	414	655	808	973
Maximum operating current draw (Un-10%)⁽¹⁾					
Standard unit	A	441	698	860	1038
Start-up current					
Standard unit		464	804	931	1091

(1) Values obtained at operation with maximum operating power input (data given on the unit nameplate)

(2) Value decreases when load lowers

(3) May vary according to the installation's short circuit ratio

THDi increases when load lowers. But the highest impact on the installation occurs when the current is maximum. Therefore compliance of the installation regarding voltage harmonic distortion at PCC (per IEC61000-2-4 or other standard) shall be usually checked at max load in order to cover all load conditions.

ELECTRICAL DATA

Compressor electrical data

Compressor	I Max (A) ⁽¹⁾ Standard	I Max (A) ⁽¹⁾ Option 16	F max (Hz) ⁽²⁾	Inverter type ⁽³⁾
06ZCE1H3AA06013	146	156	82	D3h
06ZCE1T3AA06013	184	195	105	D3h
06ZFC2T3AA06013	280	301	95	D3h/D4h
06ZJG3H3AA06013	370	392	77	D4h
06ZJG3T3AA06013	452	478	95	D4h
06ZCEAT3AA06013	169	180	103	D3h
06ZFCBT3AA06013	258	277	93	D3h

(1) Maximum compressor operating current draw over the entire range when powered at rated voltage. May be lower depending on the unit size.

(2) Maximum compressor frequency over the entire range. This frequency can be limited to a lower value depending on the unit size.

(3) Mechanical inverter type : defines inverter weight and dimensions.

Distribution of compressors per circuit

Compressor 30KAV-ZE	Circuit	350	400	450	500	550	600	650	750	800	900	1000	1100	1200	1300
06ZCE1H3AA06013	A	1	1	-	-	-	-	-	-	-	-	-	-	-	-
	B	1	1	-	-	-	-	-	-	-	-	-	-	-	-
06ZCE1T3AA06013	A	-	-	1	1	1	-	-	-	-	-	-	-	-	-
	B	-	-	1	1	1	1	1	-	-	-	-	-	-	-
06ZFC2T3AA06013	A	-	-	-	-	-	1	1	1	1	-	-	-	-	-
	B	-	-	-	-	-	-	-	1	1	-	-	-	-	-
06ZJG3H3AA06013	A	-	-	-	-	-	-	-	-	-	1	1	1	1	-
	B	-	-	-	-	-	-	-	-	-	1	1	1	-	-
06ZJG3T3AA06013	A	-	-	-	-	-	-	-	-	-	-	-	-	-	1
	B	-	-	-	-	-	-	-	-	-	-	-	-	1	1

Compressor 30KAVPZE	Circuit	350	400	450	500	550	600	650	750	800
06ZCEAT3AA06013	A	1	1	1	1	1	-	-	-	-
	B	1	1	1	1	1	1	1	-	-
06ZFCBT3AA06013	A	-	-	-	-	-	1	1	1	1
	B	-	-	-	-	-	-	-	1	1

Compressor 30KAVIZE	Circuit	500	800	1100	1250
06ZCE1H3AA06013	A	1	-	-	-
	B	1	-	-	-
06ZFC2T3AA06013	A	-	1	-	-
	B	-	1	-	-
06ZJG3H3AA06013	A	-	-	1	-
	B	-	-	1	-
06ZJG3T3AA06013	A	-	-	-	1
	B	-	-	-	1

DIMENSIONS/CLEARANCES

30KAV-ZE 350 & 400; 30KAVIZE 500; without hydraulic module

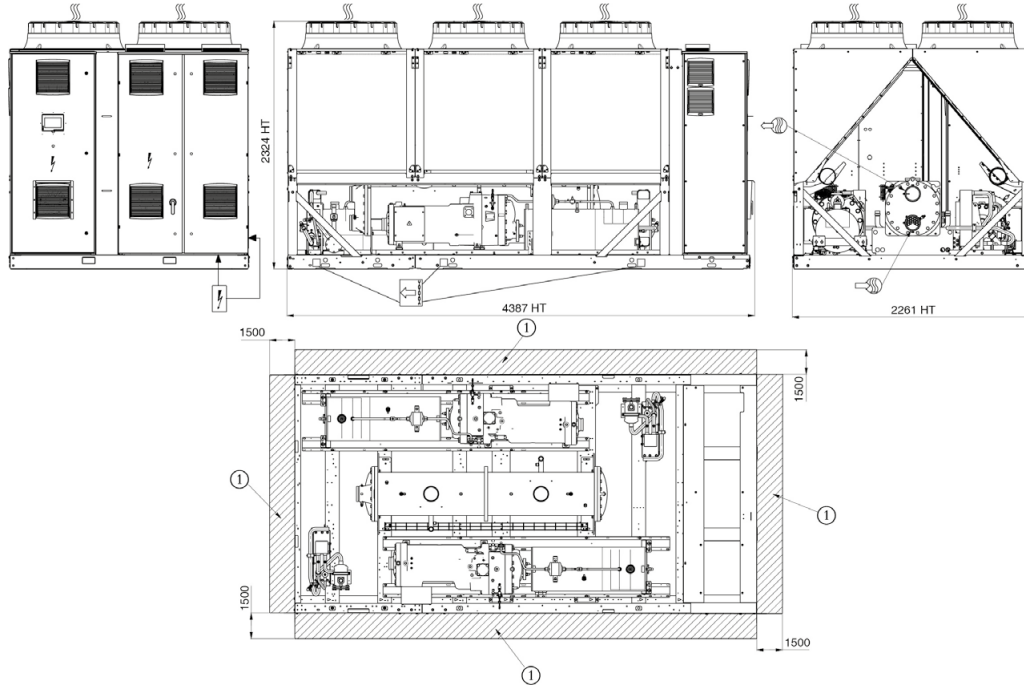



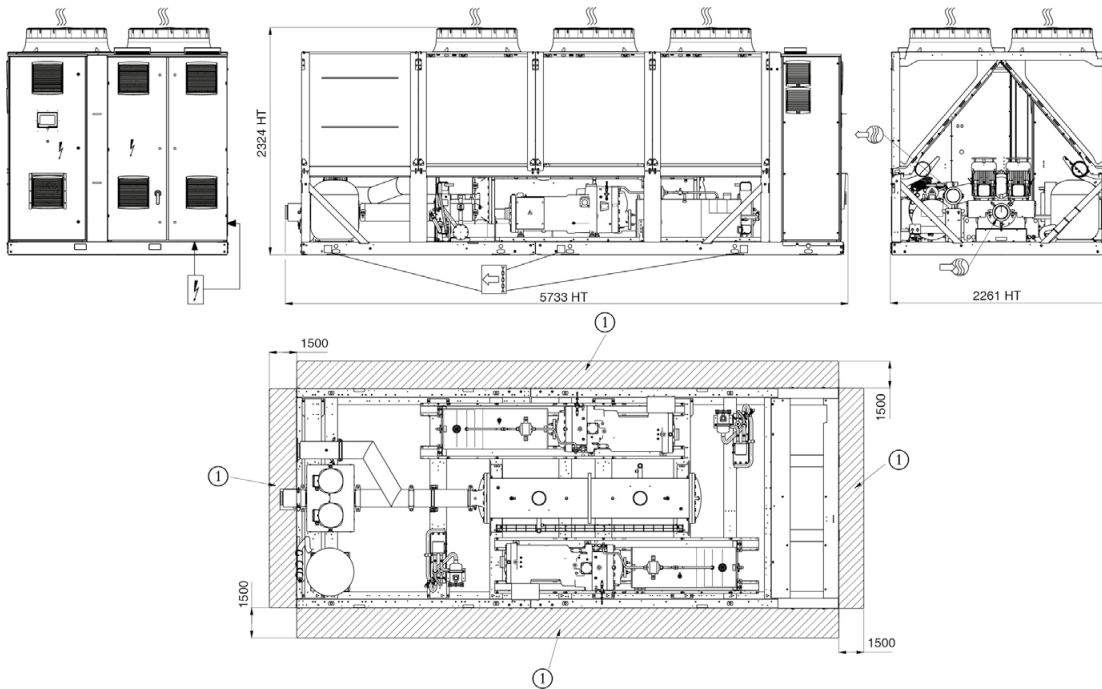

30KAV-ZE 350 & 400 with Hydraulic module



Legend

All dimensions are given in mm.

- ① Required clearances for maintenance (see note)
-  Water inlet for standard unit
-  Water outlet for standard unit
-  Air outlet – do not obstruct
-  Power electrical connection

NOTES:

Drawings are not contractually binding.

Before designing an installation, consult the certified dimensional drawings, available on request.

For the positioning of the fixing points, weight distribution and centre of gravity coordinates please refer to the dimensional drawings.

If any unit(s) are close to walls, please refer to chapter “Distance to the wall” of this document to determine the space required.

DIMENSIONS/CLEARANCES

30KAV-ZE 450 & 500, without hydraulic module

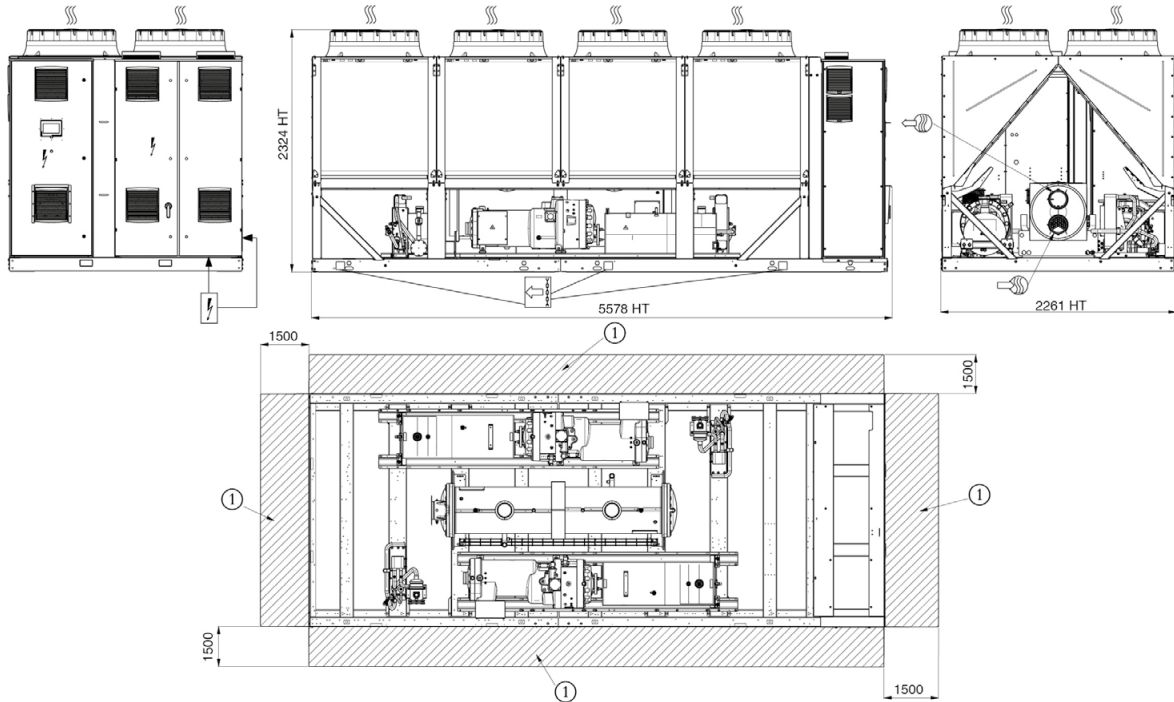



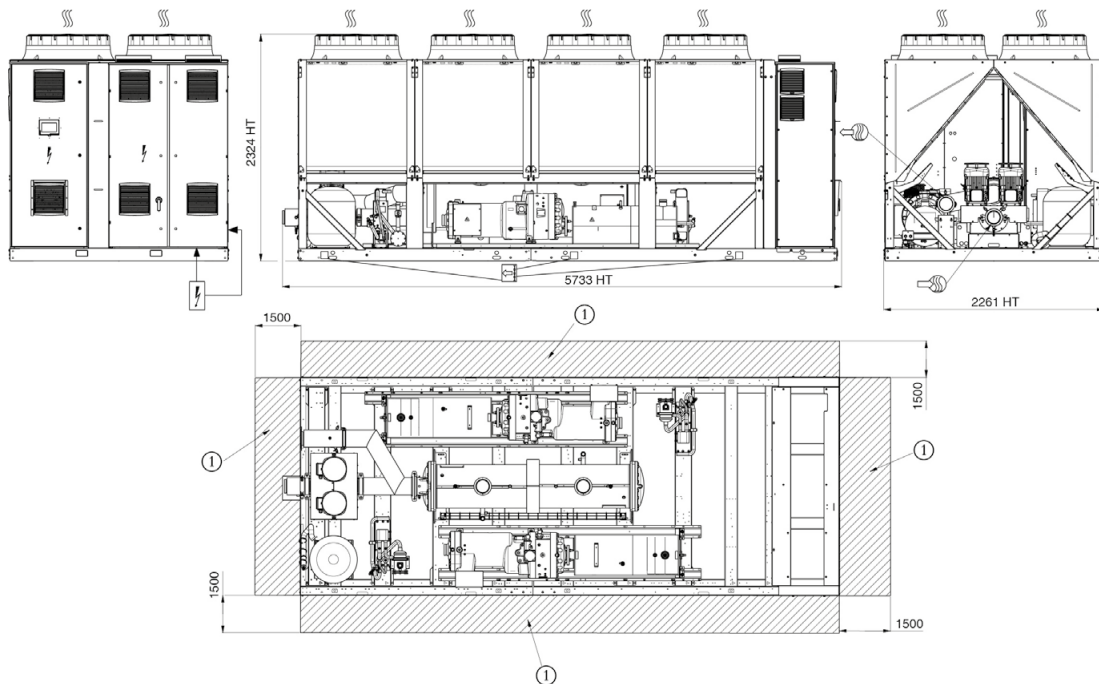

30KAV-ZE 450 & 500 with Hydraulic module



Legend

All dimensions are given in mm.

- ① Required clearances for maintenance (see note)
-  Water inlet for standard unit
-  Water outlet for standard unit
-  Air outlet – do not obstruct
-  Power electrical connection

NOTES:

Drawings are not contractually binding.

Before designing an installation, consult the certified dimensional drawings, available on request.

For the positioning of the fixing points, weight distribution and centre of gravity coordinates please refer to the dimensional drawings.

If any unit(s) are close to walls, please refer to chapter “Distance to the wall” of this document to determine the space required.

DIMENSIONS/CLEARANCES

30KAV-ZE 550 & 600; 30KAV-ZE 350, 400, 450, 500 - opt 119; 30KAVPZE 350, 400, 450, 500; 30KAVIZE 800; without hydraulic module

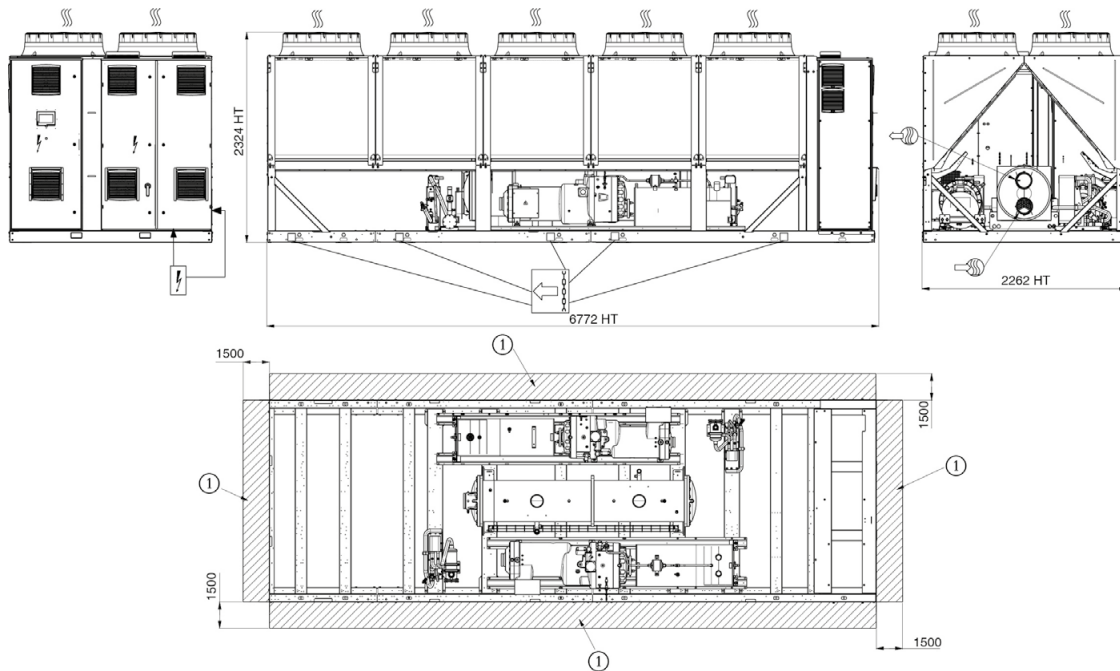



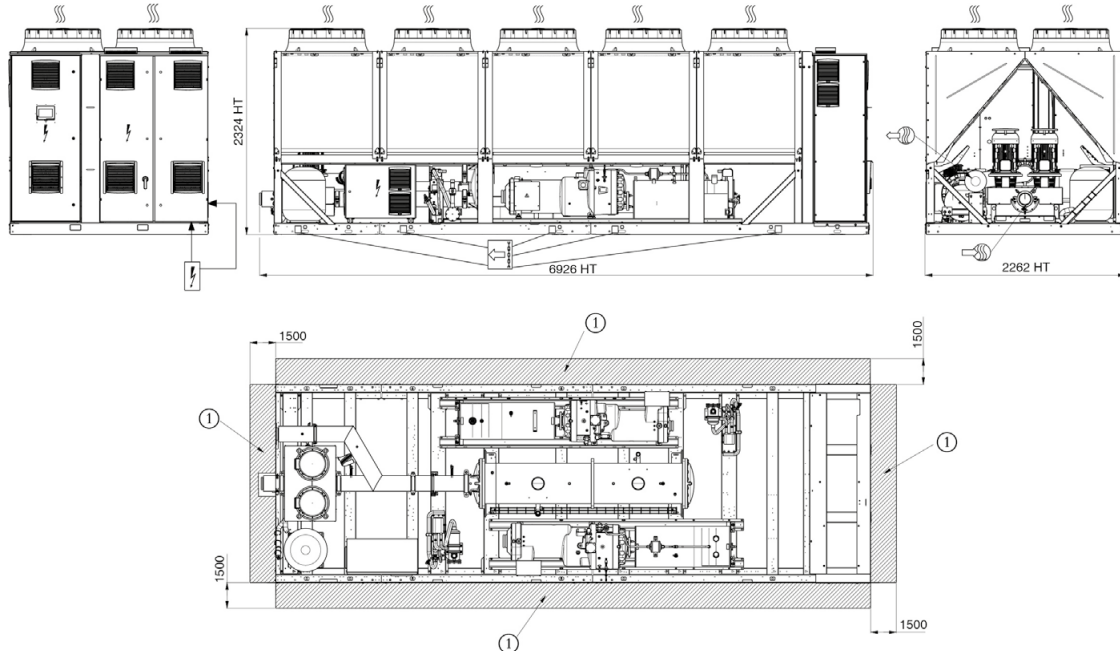

30KAV-ZE 550 & 600; 30KAV-ZE 350, 400, 450, 500 - opt 119; 30KAVPZE 350, 400, 450, 500; with hydraulic module



Legend

All dimensions are given in mm.

- ① Required clearances for maintenance (see note)
-  Water inlet for standard unit
-  Water outlet for standard unit
-  Air outlet – do not obstruct
-  Power electrical connection

NOTES:

Drawings are not contractually binding.

Before designing an installation, consult the certified dimensional drawings, available on request.

For the positioning of the fixing points, weight distribution and centre of gravity coordinates please refer to the dimensional drawings.

If any unit(s) are close to walls, please refer to chapter “Distance to the wall” of this document to determine the space required.

DIMENSIONS/CLEARANCES

30KAV-ZE 650 & 750; 30KAV-ZE 550 - opt 119; 30KAVPZE 550; without hydraulic module

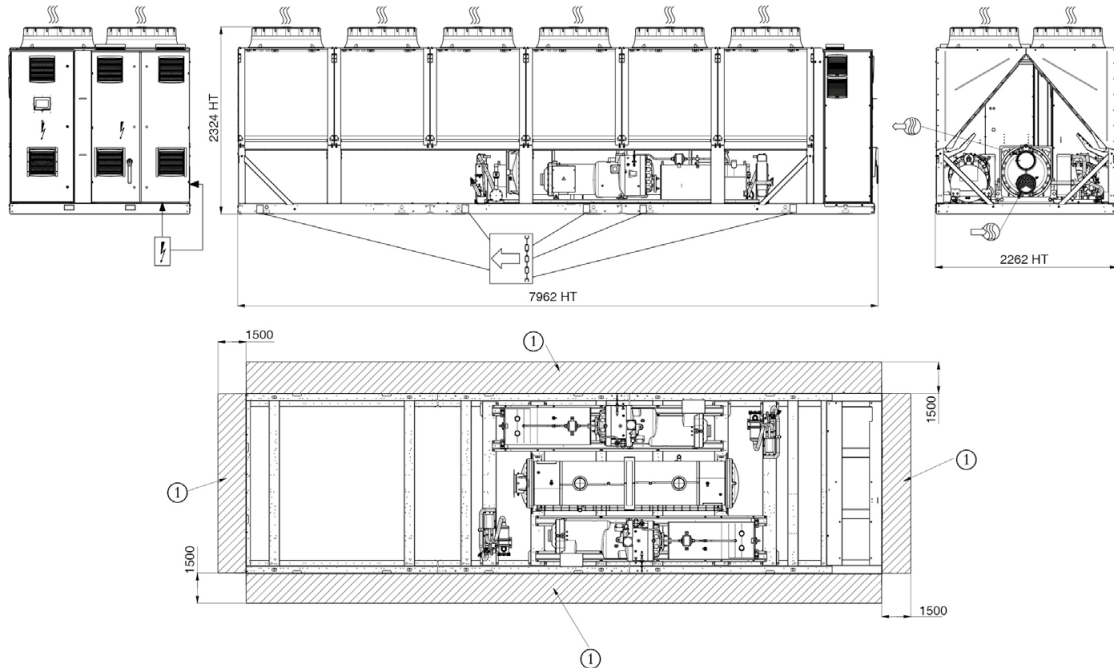

30KAV-ZE 550 - opt 119 & 30KAVPZE 550; with hydraulic module

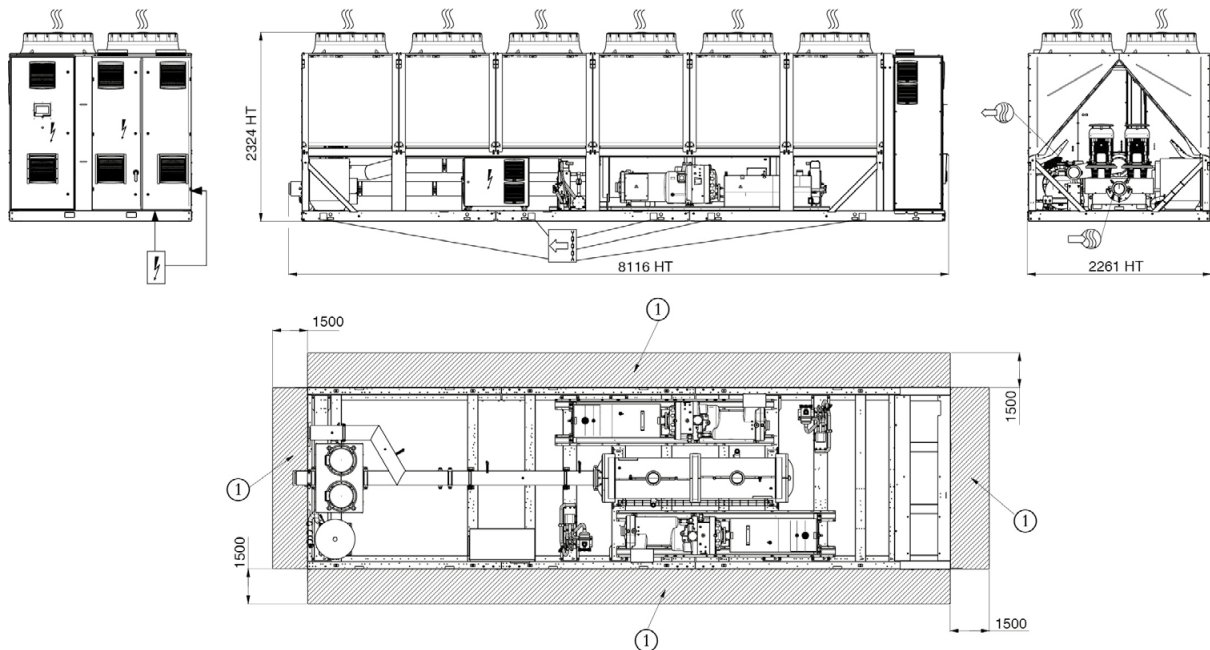

Legend

All dimensions are given in mm.

① Required clearances for maintenance (see note)

 Water inlet for standard unit

 Water outlet for standard unit

 Air outlet – do not obstruct

 Power electrical connection

NOTES:

Drawings are not contractually binding.

Before designing an installation, consult the certified dimensional drawings, available on request.

For the positioning of the fixing points, weight distribution and centre of gravity coordinates please refer to the dimensional drawings.

If any unit(s) are close to walls, please refer to chapter “Distance to the wall” of this document to determine the space required.

DIMENSIONS/CLEARANCES

30KAV-ZE 800; 30KAV-ZE 600 & 650 - opt 119; 30KAVPZE 600 & 650; without hydraulic module

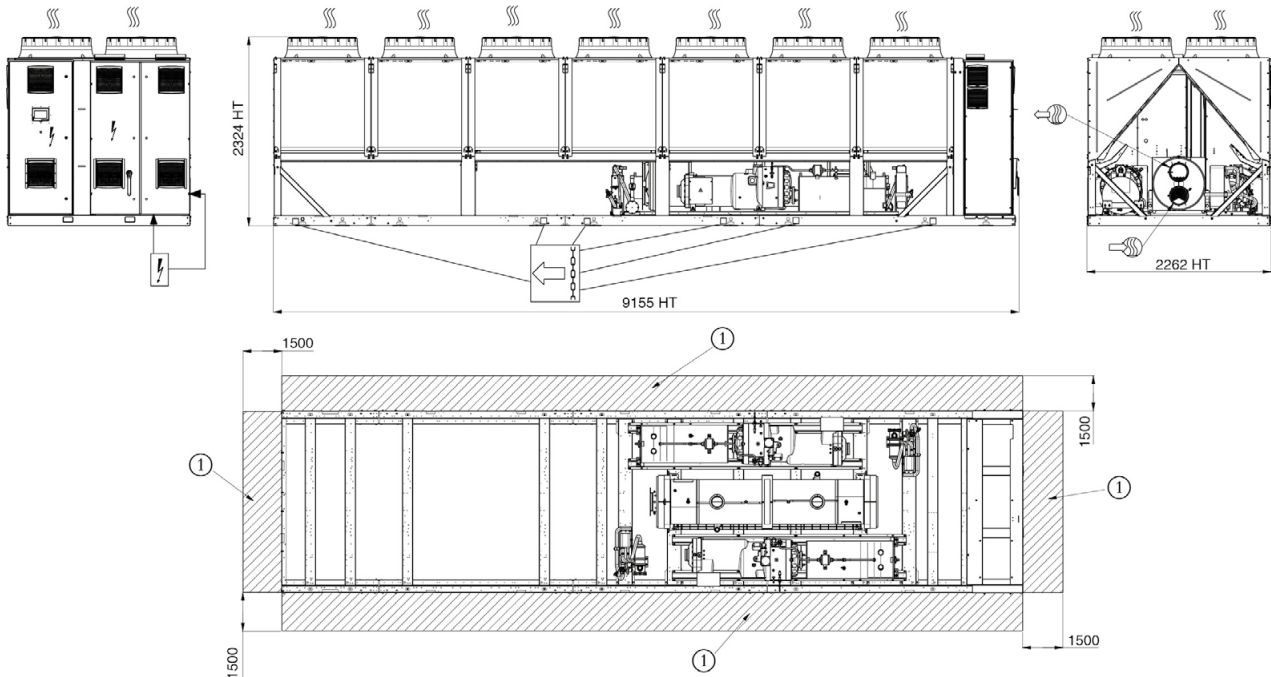

30KAV-ZE 600 - opt 119; 30KAVPZE 600; with hydraulic module

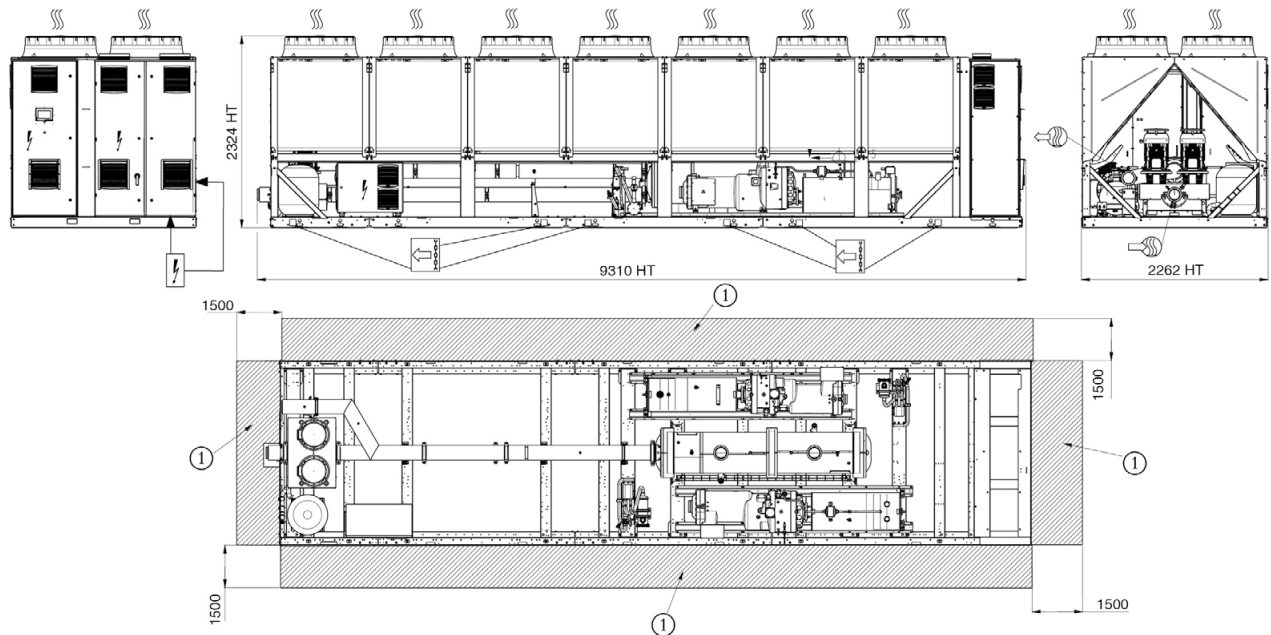

Legend

All dimensions are given in mm.

- ① Required clearances for maintenance (see note)
- Water inlet for standard unit
- Water outlet for standard unit
- Air outlet – do not obstruct
- Power electrical connection

NOTES:

Drawings are not contractually binding.

Before designing an installation, consult the certified dimensional drawings, available on request.

For the positioning of the fixing points, weight distribution and centre of gravity coordinates please refer to the dimensional drawings.

If any unit(s) are close to walls, please refer to chapter “Distance to the wall” of this document to determine the space required.

DIMENSIONS/CLEARANCES

30KAV-ZE 750 & 800 - opt 119; 30KAVPZE 750 & 800

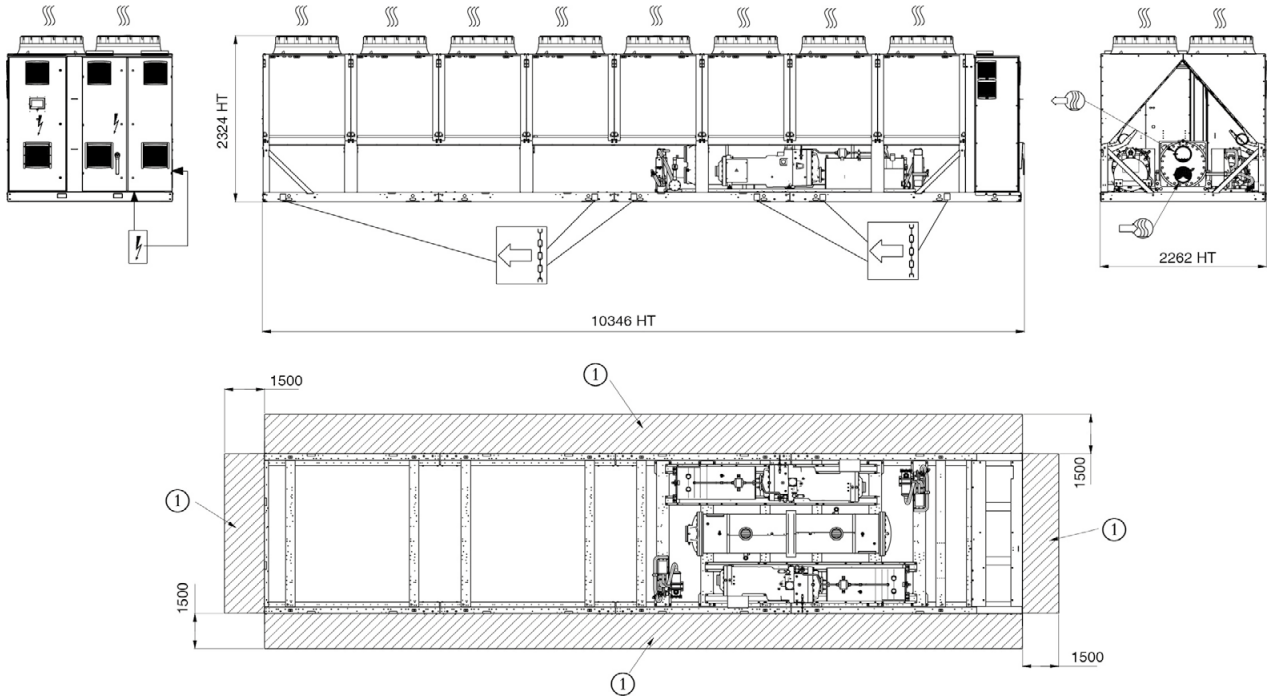

30KAV-ZE 900; 30KAVIZE 1100; 30KAVIZE 1250

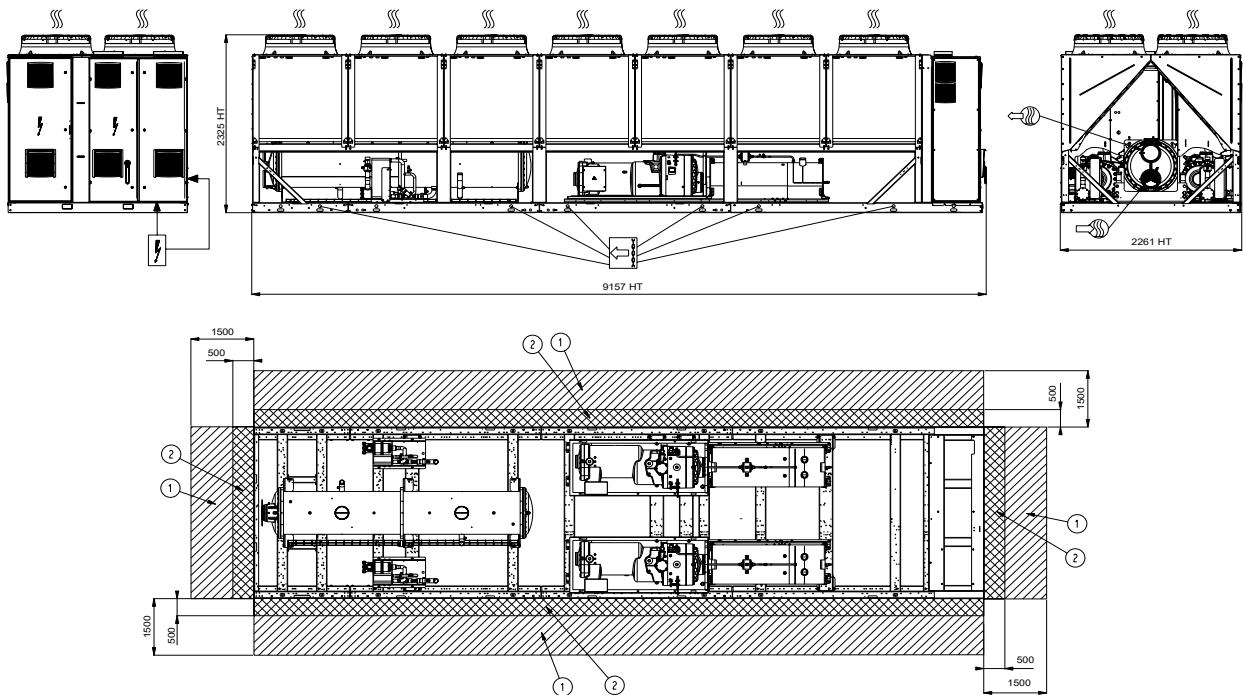

Legend

All dimensions are given in mm.

① Required clearances for maintenance (see note)

Water inlet for standard unit

Water outlet for standard unit

Air outlet – do not obstruct

Power electrical connection

NOTES:

Drawings are not contractually binding.

Before designing an installation, consult the certified dimensional drawings, available on request.

For the positioning of the fixing points, weight distribution and centre of gravity coordinates please refer to the dimensional drawings.

If any unit(s) are close to walls, please refer to chapter “Distance to the wall” of this document to determine the space required.

DIMENSIONS/CLEARANCES

30KAV-ZE 1000

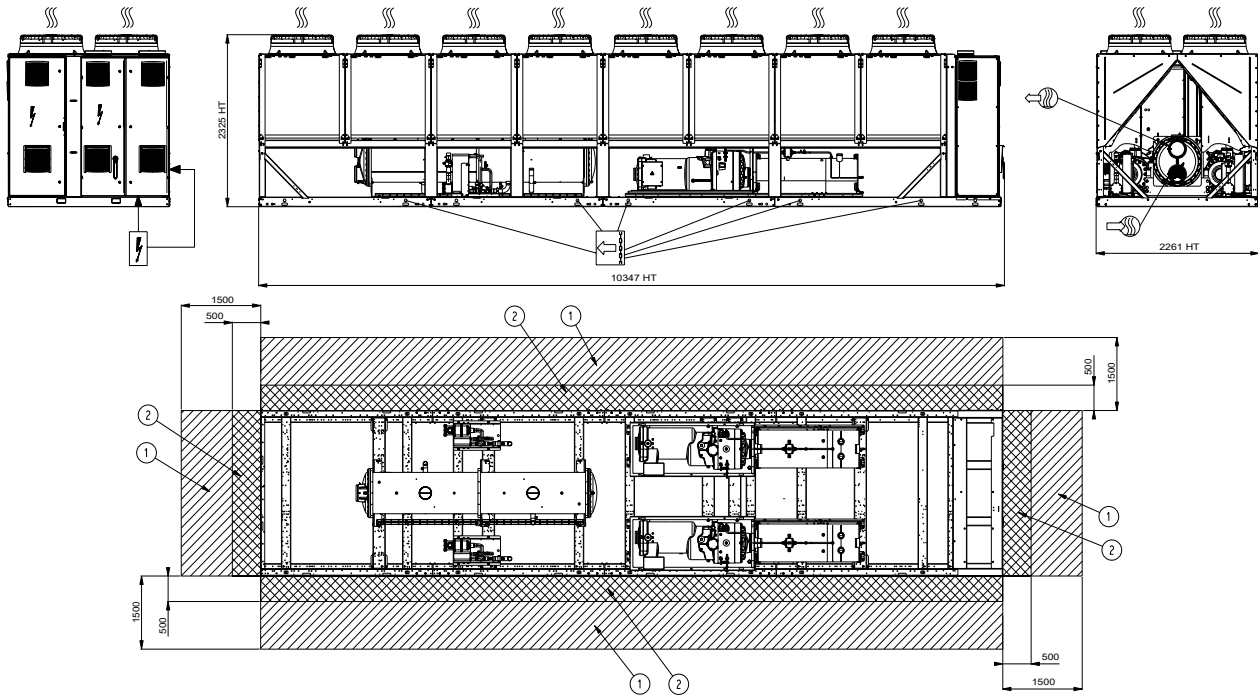

30KAV-ZE 1100; 30KAV-ZE 900 - opt 119

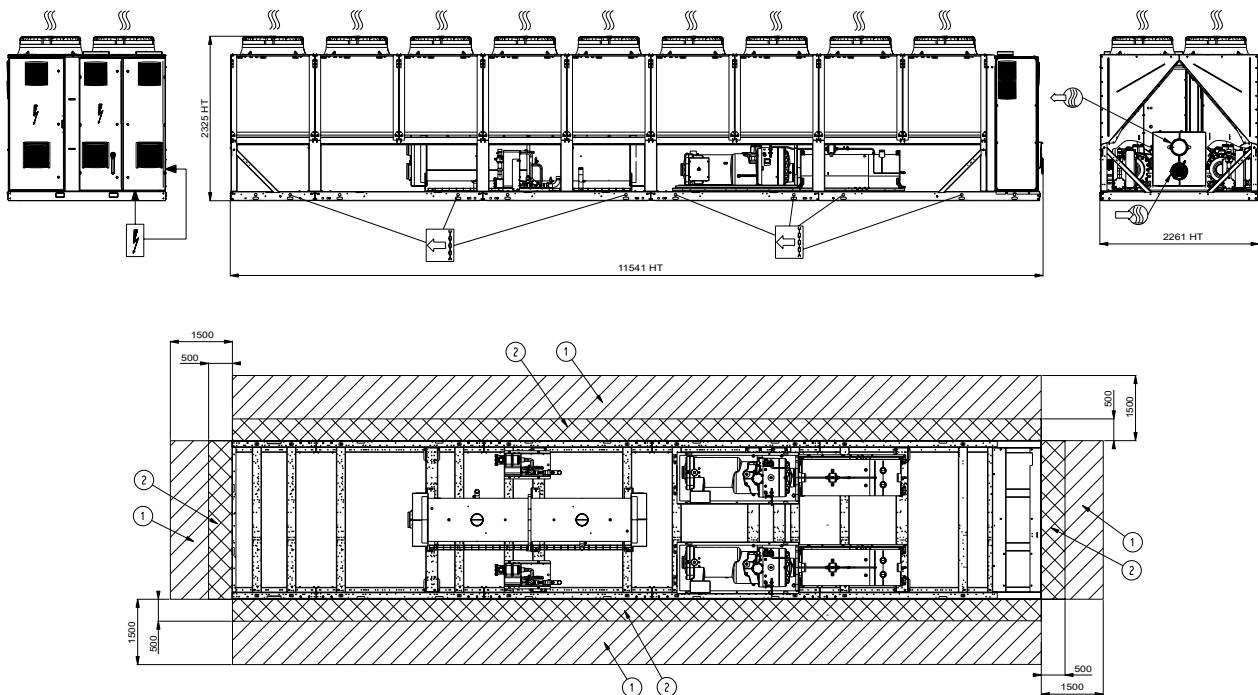

Legend

All dimensions are given in mm.

① Required clearances for maintenance (see note)

↘ Air inlet for standard unit

↙ Air outlet for standard unit

⋯ Air outlet – do not obstruct

⚡ Power electrical connection

NOTES:

Drawings are not contractually binding.

Before designing an installation, consult the certified dimensional drawings, available on request.

For the positioning of the fixing points, weight distribution and centre of gravity coordinates please refer to the dimensional drawings.

If any unit(s) are close to walls, please refer to chapter "Distance to the wall" of this document to determine the space required.

DIMENSIONS/CLEARANCES

30KAV-ZE 1200 & 1300; 30KAV-ZE 1000 & 1100 - opt 119

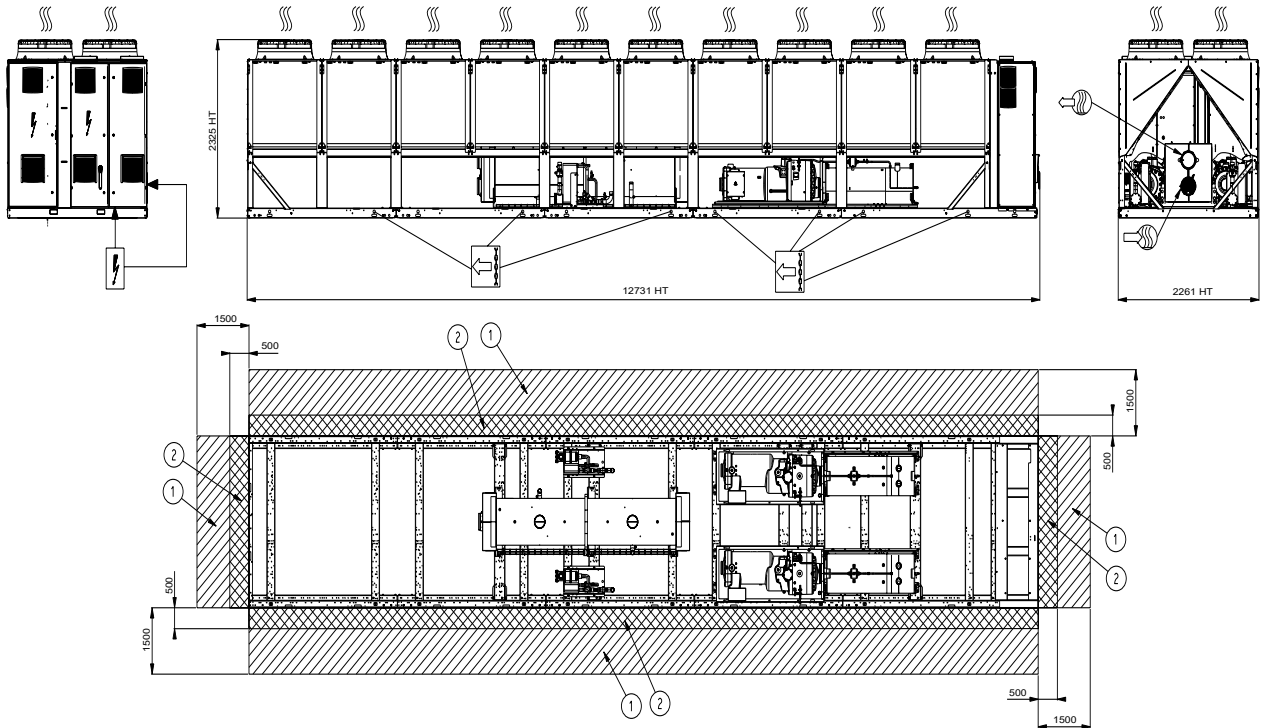

Legend

All dimensions are given in mm.

- ① Required clearances for maintenance (see note)
- Water inlet for standard unit
- Water outlet for standard unit
- Air outlet – do not obstruct
- Power electrical connection

Multiple chiller installation

It is recommended to install multiple chillers in a single row, arranged as shown in the example below, to avoid recycling of warm air from one unit to another.



If the situation at the site does not permit this arrangement, contact your Carrier distributor to evaluate the various possible arrangements. In certain situations an accessory (supplied loose at the time of purchase) can be added.

NOTES:

Drawings are not contractually binding.

Before designing an installation, consult the certified dimensional drawings, available on request.

For the positioning of the fixing points, weight distribution and centre of gravity coordinates please refer to the dimensional drawings.

If any unit(s) are close to walls, please refer to chapter "Distance to the wall" of this document to determine the space required.

Distance to the wall

To ensure correct operation for most cases:

- If $h < H$ (2,3 m), S minimum = 3 m
- If $h > H$ ou $S < 3$ m, contact your Carrier distributor to evaluate the various possible arrangements. In certain situations an accessory (supplied loose at the time of purchase) can be added.

